



## **e-DLX 750 Electric Fire**

**Model No's:  
B-1043931  
EDLXALRE-750**

### **Packing Checklist - Pack 1 of 1**

Electric Fire Engine  
Remote Control Handset\*  
Bag of Vermiculite  
Instruction Manual  
Ceramic Log Set

**\*THIS PRODUCT REQUIRES 2 X AAA BATTERIES FOR USE IN THE HANDSET (NOT SUPPLIED)**

### **IMPORTANT**

**PLEASE READ THESE INSTRUCTIONS CAREFULLY BEFORE  
INSTALLATION AND USE OF THIS ELECTRIC FIRE AND  
RETAIN FOR FUTURE REFERENCE.**

This appliance is not intended for use by persons (including children) with reduced physical, sensory or learning disabilities, or lack of experience and knowledge, unless given supervision or instruction concerning use of the appliance by a person responsible for their safety.

**If the supply cord is damaged, it must be replaced by the manufacturer, its service agent or similarly qualified persons in order to avoid a hazard.**

## **IMPORTANT SAFETY ADVICE**

**WHEN USING AN ELECTRICAL APPLIANCE, BASIC PRECAUTIONS SHOULD ALWAYS BE FOLLOWED TO REDUCE THE RISK OF FIRE, ELECTRIC SHOCK AND INJURY TO PERSONS, INCLUDING THE FOLLOWING IMPORTANT SAFETY ADVICE.**

**DO NOT** cover the heater, to avoid overheating of the product.



**DO NOT** leave the heater unattended while it is in use. Always turn the fire to the OFF position and switch off at the mains socket when not in use.

**DO NOT** leave children unsupervised whilst the fire is switched on.

**DO NOT** operate this fire with a damaged cord or plug, or after the fire malfunctions, has been dropped or damaged in any way. Contact the manufacturer.

**DO NOT** install a timer switch to operate the fire.

**DO NOT** insert or allow objects to enter any ventilation or exhaust openings on the fire. To prevent a possible fire do not block air intakes or exhaust openings in any manner.

**DO NOT** place this fire near flammable materials, surfaces or substances, as there may be a risk of fire. Keep flammable materials, surfaces or substances at least 1 metre away from the front of the product.

**DO NOT** switch on the fire if volatile vapours are present in the room.

**DO NOT** use this fire in any areas where petrol, paint or other flammable liquids are stored e.g. a garage or a workshop as the fire contains components capable of producing a spark.

**DO NOT** touch any hot surfaces such as the heater vent when the heater is in use to avoid burns and personal injury.

**DO NOT** install the heater immediately below an electrical socket outlet.

**DO NOT** use outdoors.

**CAUTION** - Some parts of this product can become hot during use and cause burns. Particular attention has to be given where children and vulnerable people are present.

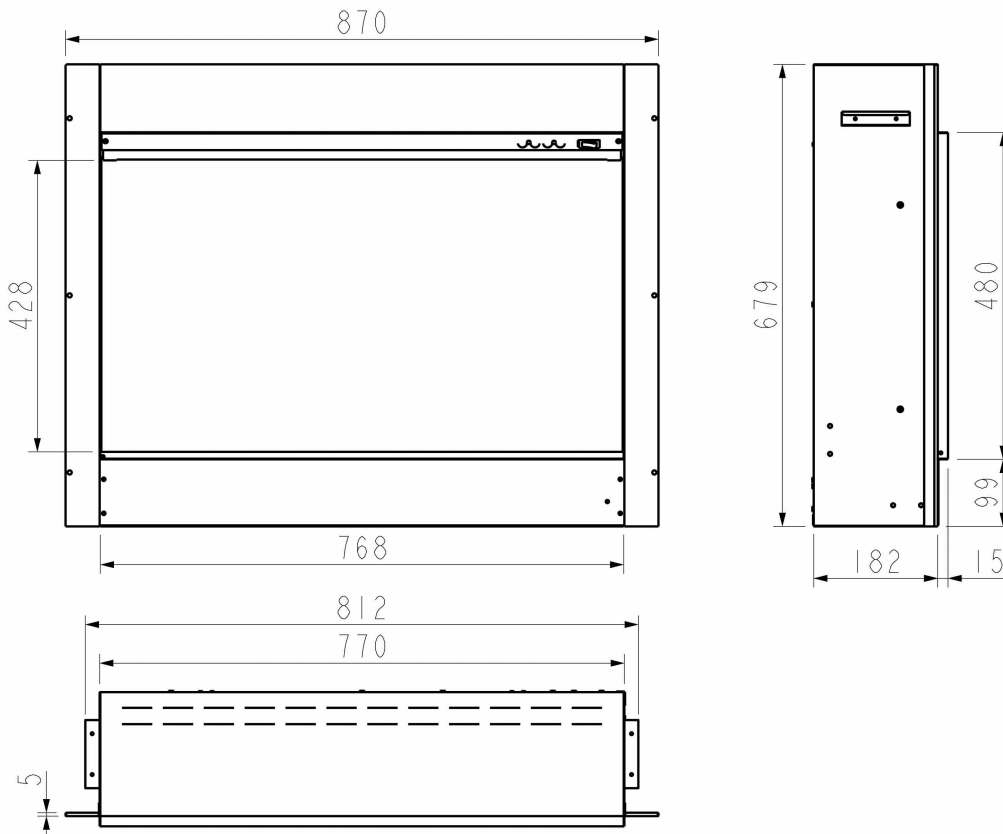
**This fire is for household use only.**

**PRODUCT TECHNICAL DATA SHEET**

<b>Supplier Name / Trademark</b>	Celsi
<b>Supplier Model Identifier</b>	B-1043931 e-DLX 750
<b>Voltage</b>	230v AC 50HZ
<b>Fuse</b>	13 Amp
<b>Nominal Heat Output (Measured)</b>	1.5kW
<b>Minimum Heat Output (Indicative)</b>	0.8kW
<b>Maximum Continuous Heat Output</b>	1.5kW
<b>Auxilliary Electrical Consumption at Nominal Heat Output</b>	0.016kW
<b>Auxilliary Electrical Consumption at Minimum Heat Output</b>	0.016kW
<b>Auxilliary Electrical Consumption at Standby Mode</b>	0.0005kW
<b>Type of Heat Output / RTC*</b>	With electronic room temperature control plus 7 day timer.
<b>Other Control Options</b>	With adaptive start control
<b>Manufacturers Name and Address</b>	BFM Europe Ltd. Gordon Banks Drive, Trentham Lakes, Stoke-on-Trent, Staffordshire, ST4 4TJ Tel: 01782 339000

\*RTC = Room Temperature Control

**Fig. 1 - Fire Dimensions**



## Unpacking

Remove and discard the plastic bag.

Be responsible when handling the packing materials.

Keep the original packaging for future transportation and/or storage.

Check all accessories are removed from the packaging before storing it away for future use.

**KEEP PLASTIC BAGS AWAY FROM CHILDREN!**

## Choosing a Suitable Location

This electric fire is designed to be fitted within an existing brick / masonry chimney breast which must be dry with the chimney capped off using a suitable chimney cap.

The appliance must be kept away from any source of damp or moist conditions. Avoid any close contact with water.

**Important Notice: To reduce heat losses and to prevent any chimney up draught affecting the operation of your fire we recommend that the chimney is blocked off.**

The chimney breast, wall or fireplace must be of sound construction and all fixings used must be suitable for the type of wall. If there is any doubt regarding the suitability of the installation site please contact your supplier.

From the front of the fire ensure that there is a minimum clearance of 50mm between any non-combustible materials. For combustible material clearances please consult with the manufacturer.

The fire can be connected direct or plugged into a mains socket which can be sited on the right hand side of the fire.

Ensure that the plug socket-outlet connection for this appliance is accessible. It **MUST** be readily accessible for easy electrical isolation in the event of servicing and replacing components etc. This appliance **MUST NOT** be located immediately below an electrical socket-outlet.

## Installation

**Installation must be carried out by a qualified and competent person.**

The fireplace opening sizes required to install the fire are:

### **e-DLX 750**

Height = 680 to 690mm

Width = 815mm to 825mm

Depth = 185mm minimum

Connect the appliance to single-phase AC supply of the voltage specified on the rating plate.

Should the fire be connected directly into the mains supply, then a fused switched spur with a 13 amp fuse must be fitted (16 amp NLD models). It is imperative that the power supply is capable of handling a load of 1500 watts (1.5kw).

This appliance must be earthed. Allow sufficient flex to enable the fire to be removed from the opening. **Do not use an extension lead.**

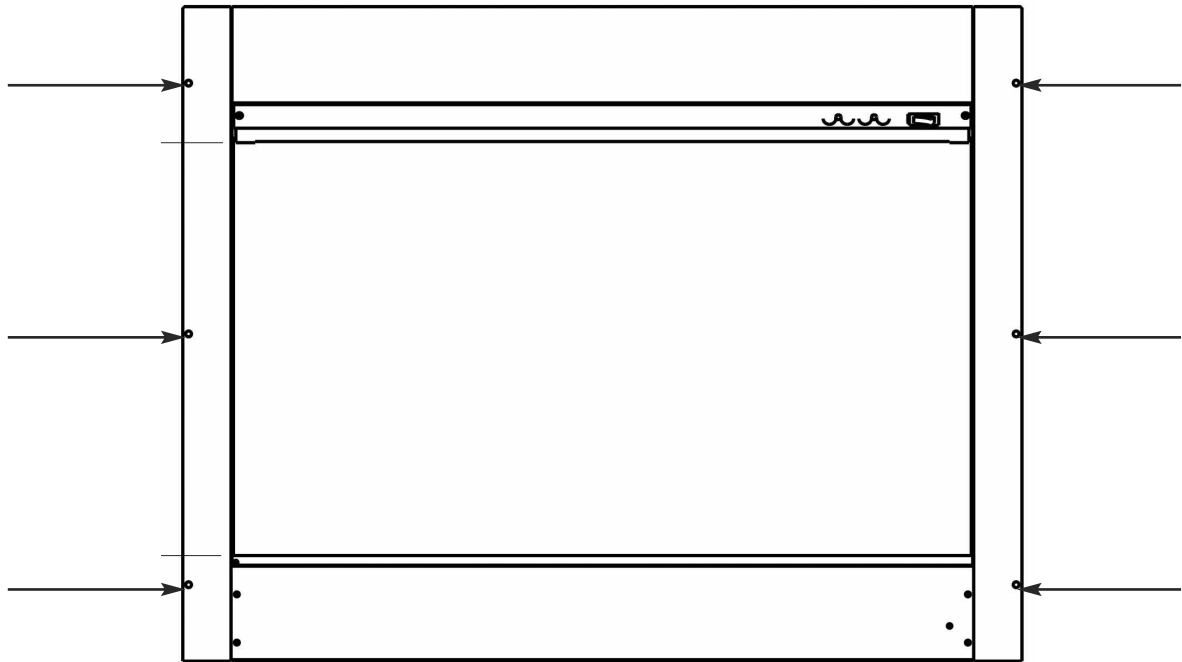
**IMPORTANT NOTE** : Models which have LED downlights included in the suite / surround will require an additional mains supply. If wired directly into the mains supply, then a fused switched spur with a 3 amp fuse must be fitted ensuring that the plug socket-outlet connection is accessible. It **MUST** be readily accessible for easy electrical isolation in the event of servicing and replacing components etc.

**Always ensure that all electrical work complies with the relevant Building Regulations and the Electrical Code of Practice. All electrical work should be carried out by a qualified electrician.**

## e-DLX 750 Wall Mounting

The base of the fire opening must be solid, level and firmly fixed to safely support the weight of the fire.

**Fig. 2**



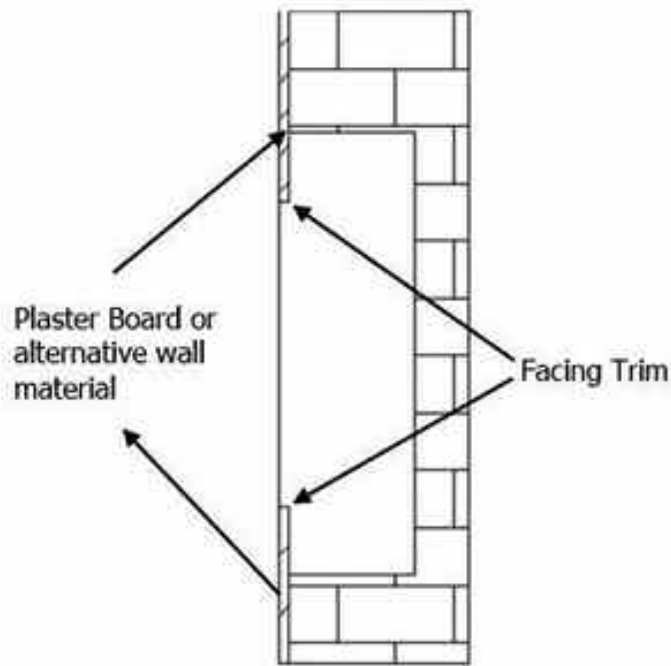
The fire is held in place using 6 off suitable screws and fasteners in the 6 off fixing holes on the sides of the appliance as shown above in figure 2.

A false studded chimney breast can be built with a plastered finish to encase the fire

The chimney wall can now be finished with plasterboard or an alternative facing material which terminates at the facing trim.

The fire can be fitted direct into the chimney breast and plastered flush up to the facing trim

**Fig. 3**



**e-DLX 750 with Trim option**

Installation is the same principle as wall mounting but the fire is screwed to the plastered wall to ensure that the facing trims protrude from the fire. For fitting of the trim please refer to the instructions included with the trim.

**Laying the Ceramic Logs**

The Logs and the vermiculite are packed in the box. Fit the logs as indicated below in figure 4, minor adjustments can be made to suit the individual items supplied. Position the vermiculite as also shown in figure 4.

**Fig. 4**



## Operating the Fire

This fire can be operated using 4 methods:

**Manual Control** using the controls on the fire

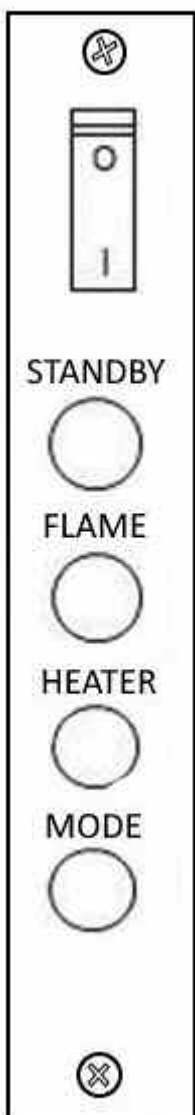
**Remote Control** using the included remote-control handset

**Celsi App Control** using smartphone or tablet voice control, Alexa or Google Assistant

### Manual Control

This fire can be operated manually using the control panel as shown below in figure 5.

**Fig. 5**



#### **ON / OFF Power Switch**

This switch is used to turn the mains supply to the fire ON or OFF.

This needs to be in the ON position for both manual and remote operation.

#### **STANDBY**

Used to switch fire ON or OFF into standby mode.

#### **FLAME**

Pressing this button will cycle through the 4 different flame brightness levels.

#### **HEATER**

Use this button to select Low Heat, High Heat or heater OFF.

When LOW heat is selected the indicator light will glow amber for 5 seconds. When HIGH heat is selected the indicator light will glow red for 5 seconds.

Please note the heater will only operate when the room temperature is below the temperature set on the handset, which can be adjusted using the remote control or app. When the heater switches off, the fan will still continue to run for a short period to allow the fire to cool down.

#### **MODE**

Use this button to cycle through and select 1 of the 16 preset LED colour combinations. Press and hold until a confirmation beep is heard to set on 'Colour Animation' mode to slowly cycle through all the colour combinations. Press and hold again until a confirmation beep is heard to clear the setting.



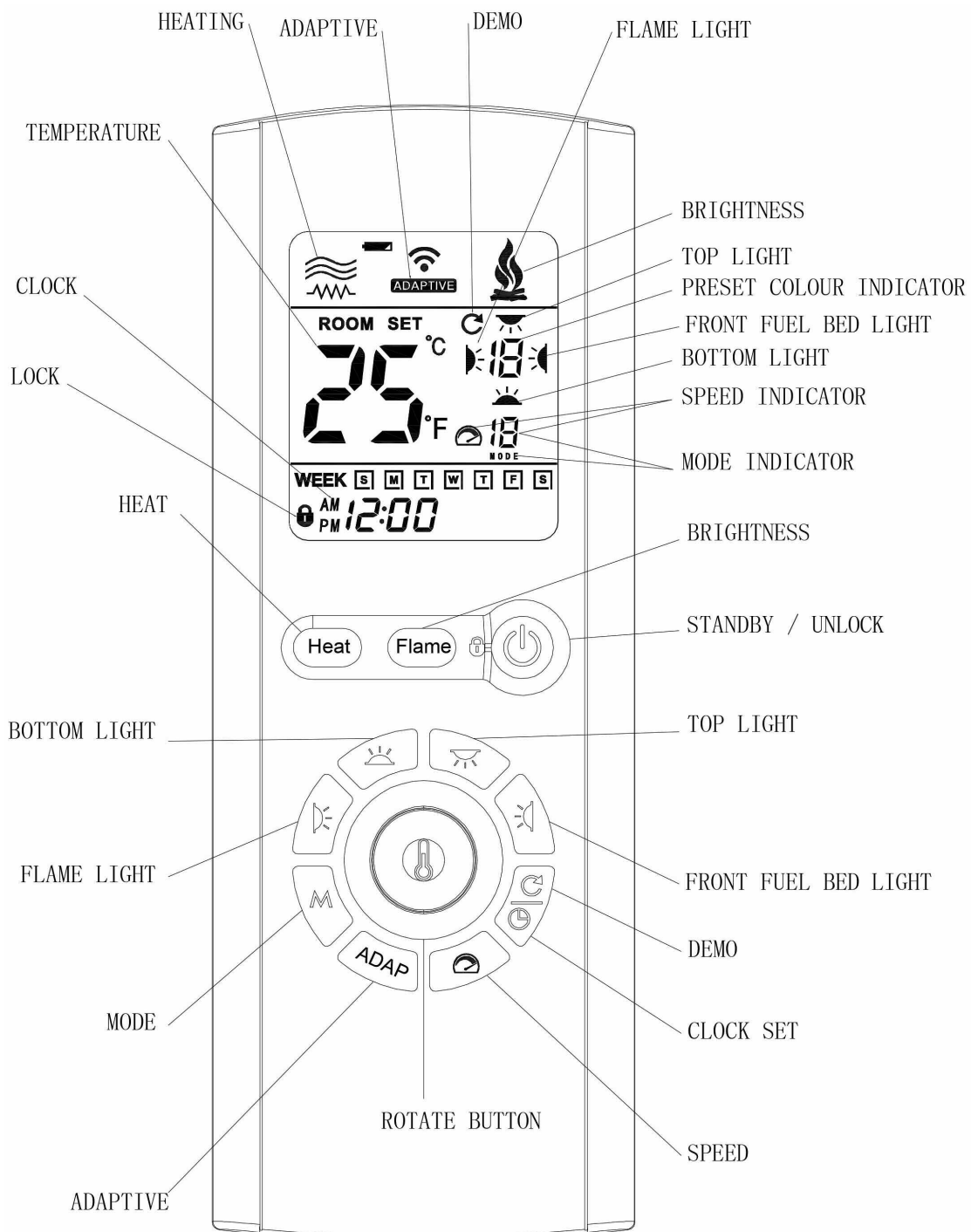
## Remote Control

Remove the battery cover on the rear and insert 2 x AAA batteries ensuring the batteries are fitted correctly. Refit the cover. Please ensure old batteries are disposed of responsibly by contacting your local authority about recycling schemes.

Ensure that the ON / OFF Power Switch on the fire is in the ON position.

Before the handset as shown below in figure 6 can be used the current day and time will need to be set (see clock setting instructions on the next page).

**Fig. 6**



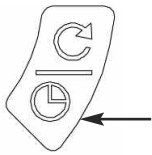
To use the remote handset ensure it is pointed directly towards the fire and press the appropriate button to operate the fire.

## Operating the Fire and Child Lock mode



1. Use the On/Off button to switch the fire On and Off.
2. The remote will automatically lock if left for approximately 90 seconds.
3. To disable the child lock press the On/Off button once.  
*Note: that after a short period of time the handset will automatically enable the Child Lock mode as detailed in item 2 above.*

## Clock Setting



1. Press the Clock Set button, which will start the day cursor to blink. Using the selection wheel rotate to the current day e.g. S M T W T F S then press the Clock Set button to confirm.
2. The hour will now be blinking, set using the selection wheel and confirm using the Clock Set button.
3. The minute will now be blinking, set using the selection wheel and confirm using the Clock Set button.

## Flame Setting



1. Pressing this button will cycle through the 4 brightness settings of the LED flame effects.

## Heat Setting



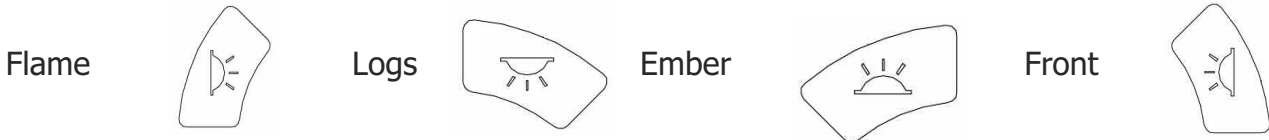
1. Use to change the heater setting from LOW, HIGH and OFF
2. When the heater is ON the actual room temperature is displayed on the handset
3. Press the HEAT button then by using the selection wheel you can set the desired temperature, this will save after 5 seconds and the room temperature will be displayed

*Note: the heater will only operate when the room temperature is below the temperature set on the handset. When the heater switches off, the fan will still continue to run for a short period to allow the fire to cool down.*

## LED Colour Settings

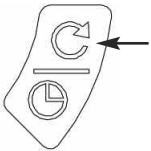


1. Press the Mode/Set button and use the selection wheel to select one of the 16 preset LED colour combinations (the preset number will be displayed flashing on the handset), press again to lock the selection (or the icon will stop flashing after 5 seconds)  
If preferred, the LED colour settings can be changed individually for the



<b>Flame Button</b>	=	<b>Rear Flame Lights</b>
<b>Logs Button</b>	=	<b>Downlight Lighting</b>
<b>Ember Button</b>	=	<b>Underbed Lighting</b>
<b>Front Button</b>	=	<b>Front Log Light Projection</b>

2. Press the one of the buttons above (symbol number will flash on display) and use the selection wheel to select your required colour setting for the specific lighting function, press again to lock the selection or icon will stop flashing after 5 seconds.  
NOTE : Front Button only switches ON or OFF (no adjustment available)



Alternatively the fire can be set to Colour Animation mode

1. Pressing the Colour Animation mode button will set the Lighting to a red glow and then will slowly cycle through the 16 preset colour combinations.
2. Press the Colour Animation mode to exit the animation mode.

## Flame Speed Adjustment



1. Flame speed can be adjusted between setting 1 to 4
2. Press the flame speed button to toggle through the flame speed to achieve the desired setting.

## Adaptive Mode



1. Adaptive mode works in conjunction with the timer programmes. When adaptive model is turned ON the fire monitors the room temperature in relation to the selected target temperature. If the room temperature is sufficiently lower that the selected temperature the Adaptive mode will instruct the fire to switch on up to 10 minutes earlier than the set time to ensure the room is at the required temperature at the set time.

# Celsi App Control

The Celsi app can be downloaded from the IOS App Store or the Google Play Store by either searching for Celsi or by scanning the QR code using a smart phone or tablet.



The Celsi app can be used alongside the remote handset and provides additional feature of 7 day Timer function.

**\*\* During the initial set up of the App, the fire needs to be in pairing mode \*\***

## Pairing Mode

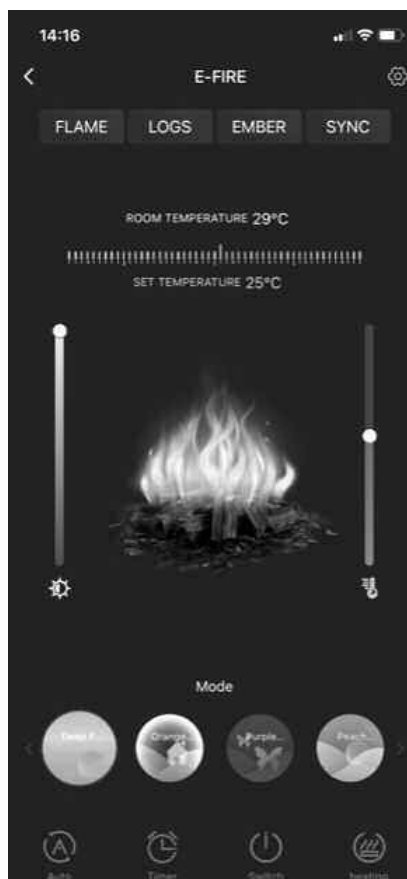
With the fire ON press the standby button to hear a beep and continue holding for 5 seconds to observe a red flashing light on the rear screen. When this light is flashing the product is in pairing mode.

## App Setup

1. Open the app and when prompted either create a new Celsi account or Login using your existing account details.
2. Once logged in, accept the notification to allow permission for the Celsi app to access Notifications and Bluetooth.
3. On your smart device ensure that Bluetooth and Wi-Fi are switched ON.
4. Ensure the fire is in pairing mode.
5. On the app the All Devices screen will be displayed. Press the + button at the top R/H corner.
6. Allow the app to connect to devices on local network.
7. Click on Add button to discover devices.
8. Click on Manual Input and add the name and password of the Wi-Fi network you are connecting the fire to.
9. Follow the on screen instructions to add device.

## Using the App

**Fig. 7**



The Home page of the app will allow you to operate and customise the appearance of your fire using the touchscreen interface as shown opposite in figure 7.

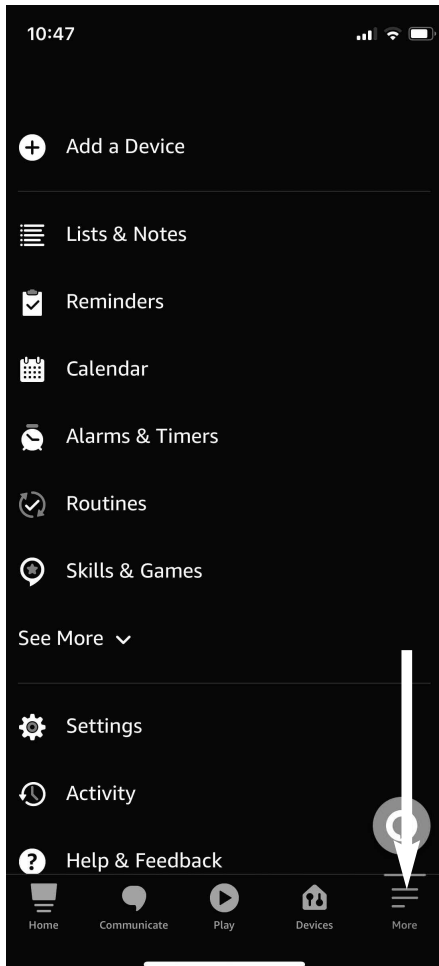
The app has all the same features as the remote handset along with an additional 7 day Timer function. Using this function you can set timers for the fire to switch on at a given time

Further information is available within FAQ section of the app.

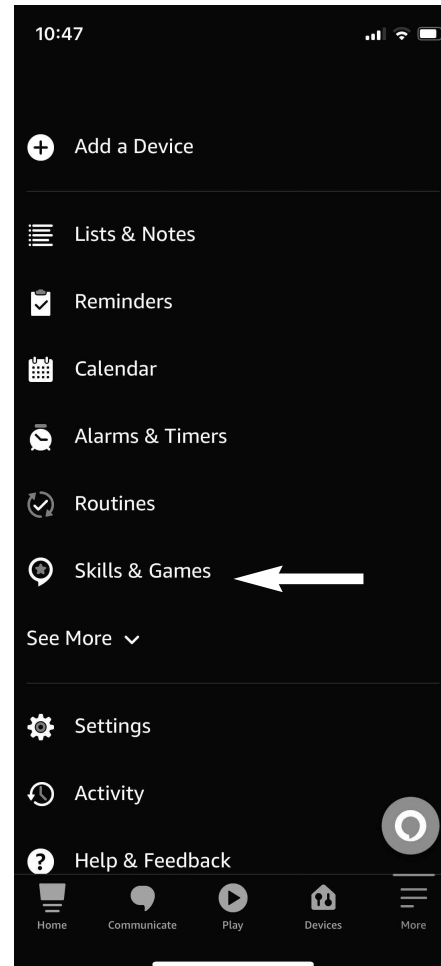
## Connection to Alexa

Once you have set up your Celsi account and successfully paired your device you can now also connect to Alexa.

**Fig. 8**



**Fig. 9**

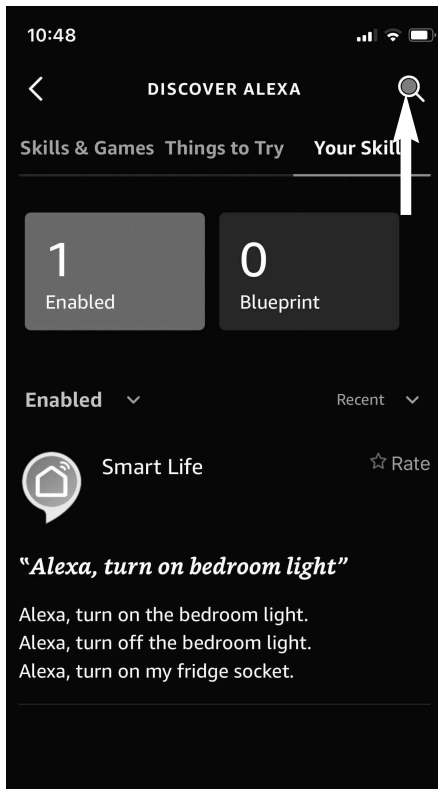


To connect, open the Alexa App and select the "More" tab in the bottom right hand corner as shown in figure 8 above.

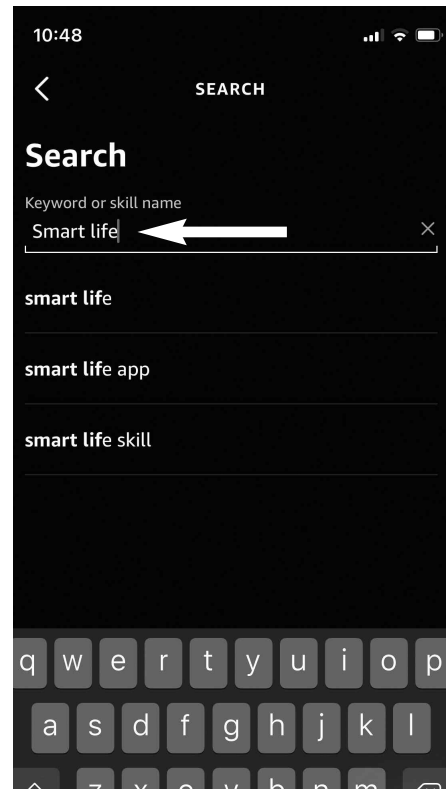
Then select the "skills and games" tab as indicated in figure 9 above.

Then click the "search" icon in the top right hand corner as shown below in figure 10, then search for the "smart life" skill by typing "smart life" into the search box as shown below in figure 11.

**Fig. 10**

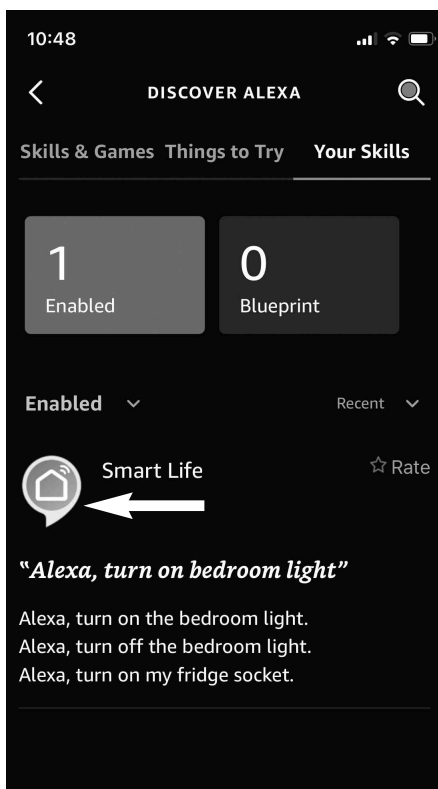


**Fig. 11**

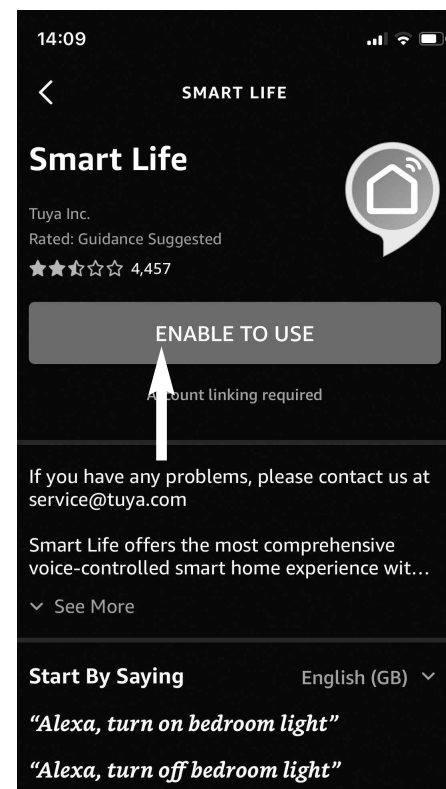


Install onto your device by clicking the "smart life" icon shown below in figure 12, then the "enable to use" icon as shown in figure 13.

**Fig. 12**



**Fig. 13**

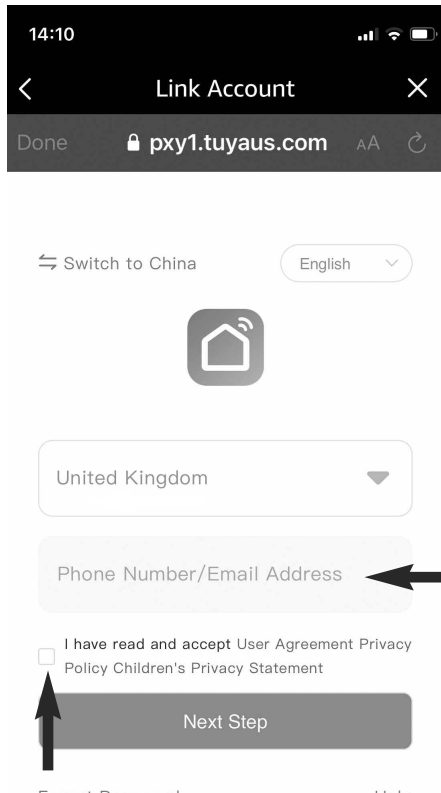


This will prompt you for your e-mail address and password that you used when registering the Celsi APP as shown below, enter the e-mail address and tick the user agreement box as indicated below in figure 14.

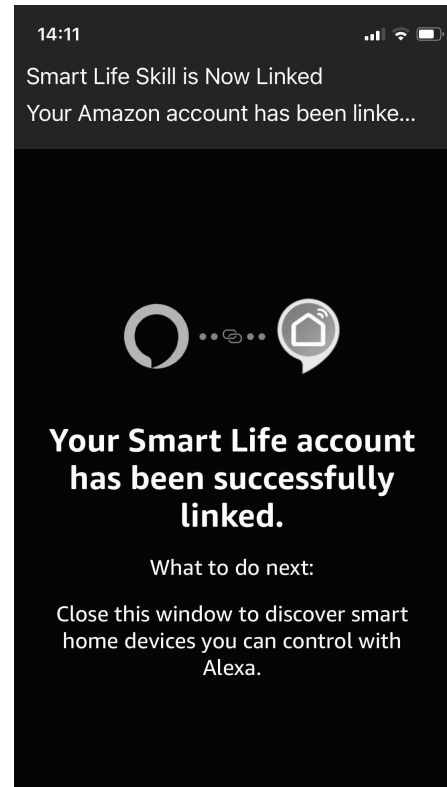
Complete the verification puzzle as prompted, then enter your password and complete a second verification puzzle as requested.

This will then bring up the confirmation page that the account has been successfully linked as shown below in figure 15.

**Fig. 14**



**Fig. 15**



The product should then operate from voice activation.

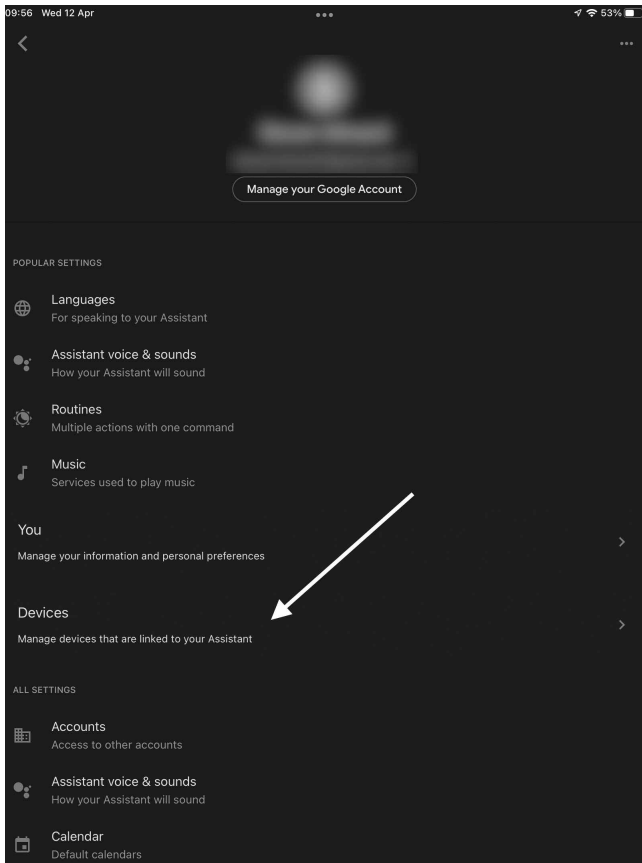
i.e. "Alexa, turn fire on", "Alexa, turn fire off".



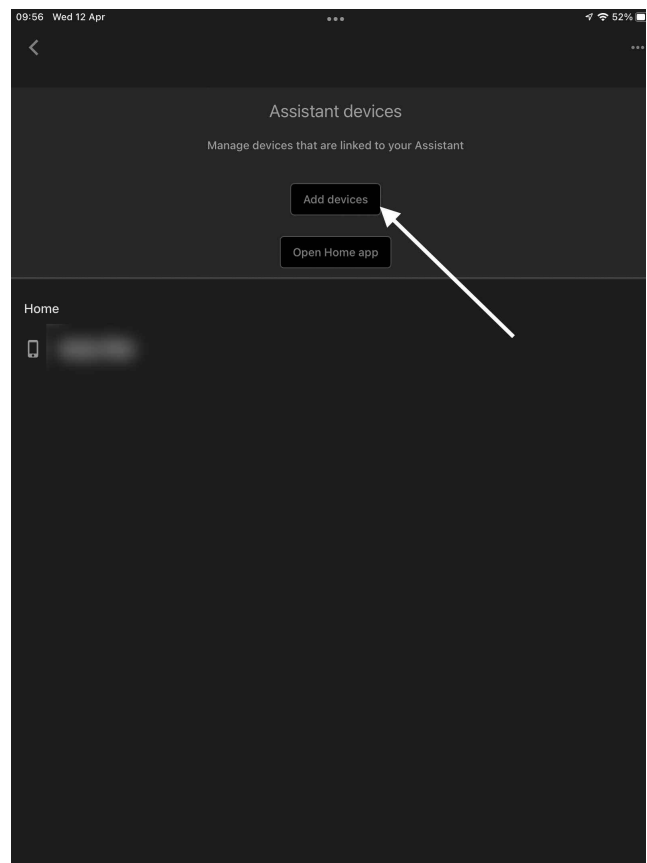
## Connection to Google Assistant

Once you have set up your Celsi account and successfully paired your device you can now also connect to Google Assistant.

**Fig. 16**



**Fig. 17**

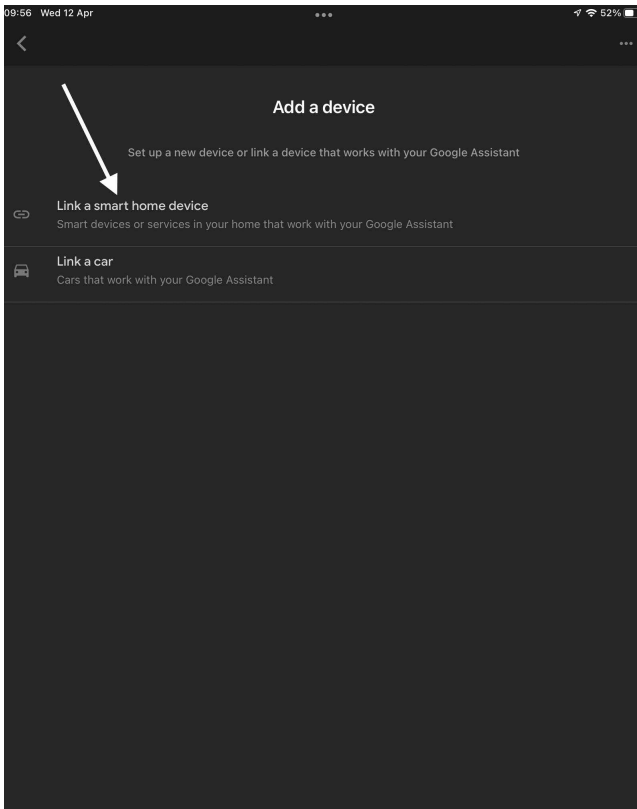


To connect, open the Google Assistant App and select the "Device" tab on the left hand side as shown above in figure 16, then click the "add devices" tab when prompted as shown above on the right in figure 17.

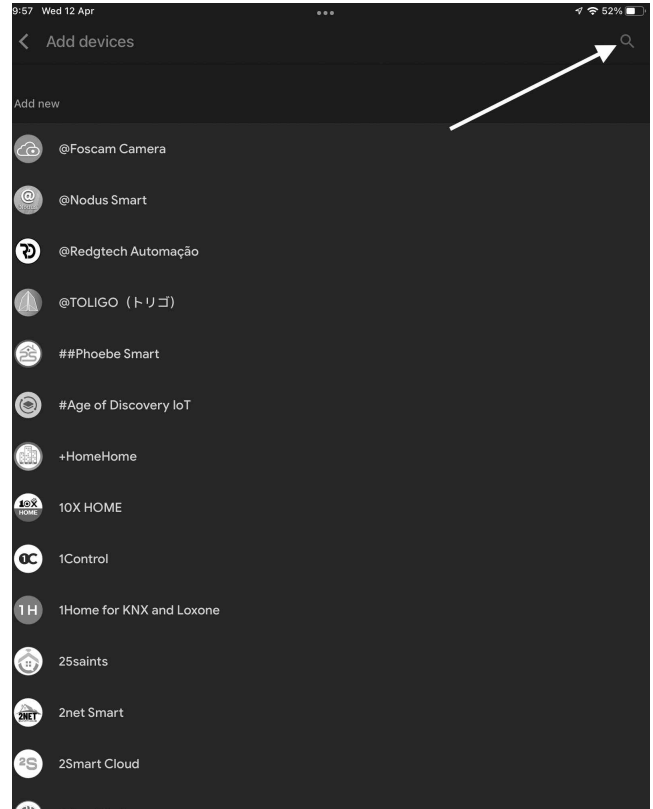
Then select the "link a smart home device" tab as indicated overpage in figure 18.

Select the "link a smart home device" tab as indicated below in figure 19.

**Fig. 18**

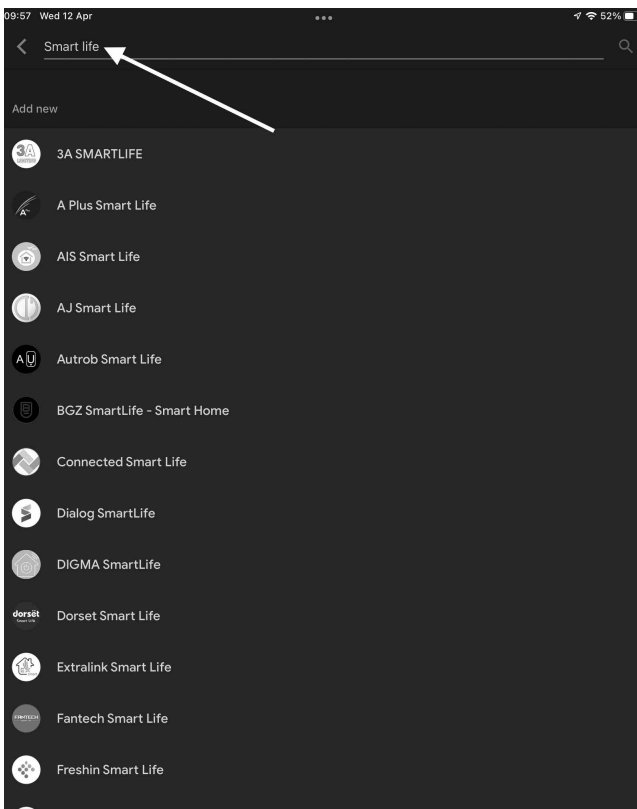


**Fig. 19**

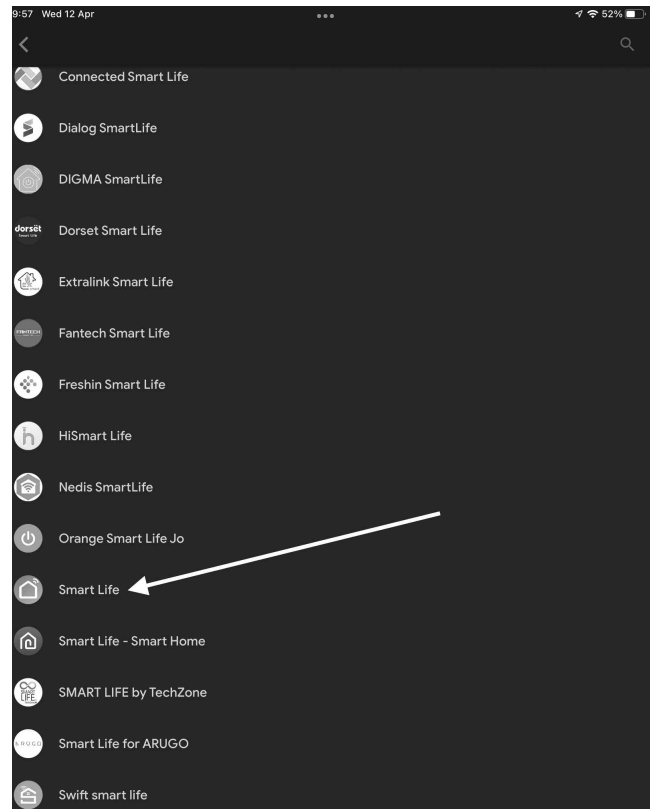


Click the "search" icon in the top right hand corner as shown figure 19 above, then enter "smart life" as the searched for as shown in figure 20. Select the "smart life icon as shown in figure 21 below.

**Fig. 20**

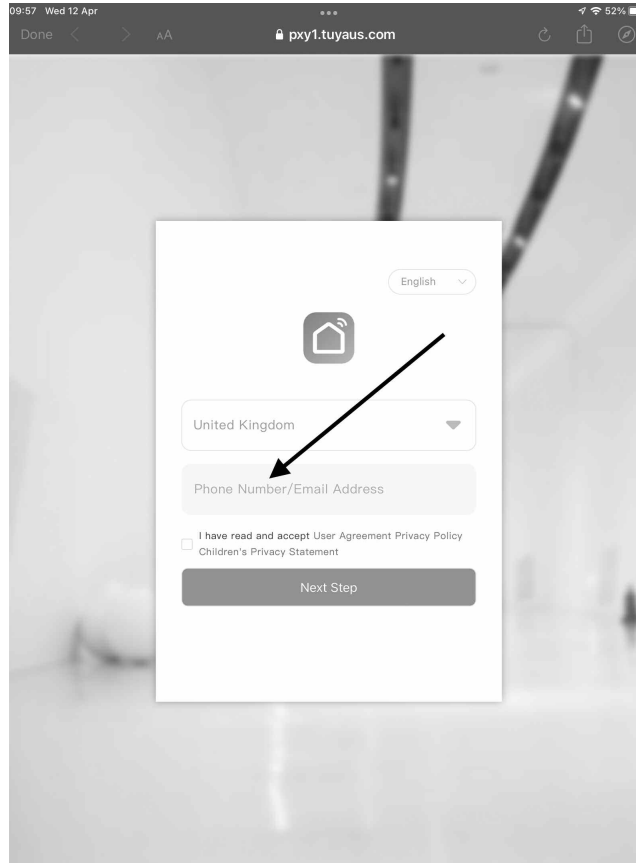


**Fig. 21**



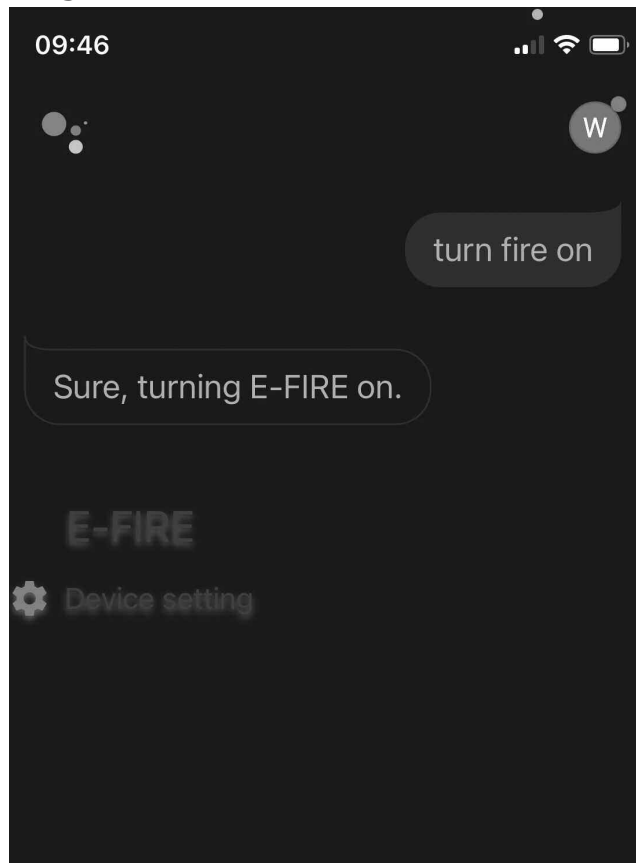
This will prompt you for your e-mail address and password that you used when registering the Celsi APP as shown below, enter the e-mail address and tick the user agreement box as indicated below in figure 22.

**Fig. 22**



The product should then operate from voice activation, open the google assistant app, click then click the microphone logo at the bottom centre and give instruction i.e. "turn fire on", "turn fire off" as shown in figure 23 below.

**Fig. 23**



## IMPORTANT

This fire is fitted with an automatic thermal cut-out safety feature to reduce the risk of damage to fire due to overheating. If the fire overheats the heater element will cut out whilst the fan will still continue to run to allow the fire to cool down sufficiently.

Once the fire has cooled down the thermal cut-out will reset itself and switch the heater back on. If the problem persists switch the fire off and disconnect the power at the switch and plug socket. Check that the heater warm air outlets and the inlets are not obstructed (the outlets and inlets are situated on the underside of the fire body).

If the heater is still not operating correctly disconnect the fire and seek expert advice.

## Maintenance Instructions

Always remove the plug from the socket-outlet and allow the heater to cool down before cleaning. User maintenance should only be carried out by a competent person.

Light accumulated dust may be removed from the fire with a soft dry cloth.

The exterior surface of the fire can be cleaned with a soft damp cloth (not dripping wet). Dry the exterior surface before operating the heater.

Household glass cleaner can be used on the fire glass.

## WARNING!

Do not immerse the heater in water.

Do not use any cleaning chemicals such as detergents and abrasives.

Do not allow the interior to get wet as this could create a hazard.

In the event of malfunction contact the manufacturer, do not try to repair the heater yourself as this may result in a fire hazard or electric shock.

## Environment

**Fig. 24**



Do not dispose of electrical appliances as unsorted municipal waste. Use separate collection facilities. Contact your local government for information regarding the collection services available in your local area. If electrical appliances are disposed of in landfills or dumps hazardous substances can leak into the groundwater and get into the food chain, thus damaging your health and wellbeing. When replacing old appliances with new ones the retailer is legally obligated to take away your old fire for disposal free of charge.

## Warranty

Congratulations on the purchase of your electric fire. This fire by BFM Europe Ltd is guaranteed for 5 years from the date of purchase against faulty materials or workmanship.

If purchased in the UK please note the 5 year guarantee comprises of 24 months of parts and labour with an extended 36 months of parts only. If your fire is found to be defective within 24 months from the date of purchase, we or our authorized agent will repair the faulty component on site.

If purchased in the EU please consult the guarantee card that is supplied with your product by the approved Celsi Fires retailer for warranty terms and conditions.

This warranty does not cover consumable items which have a limited lifespan.

If a problem should occur, the nature of the problem together with the date of purchase and installer information should be immediately reported to the retailer that the fire was purchased from. Proof of purchase will be required so the original invoice should be retained.

**B-1044067**  
**Issue 2**



BFM Europe Ltd  
Gordon Banks Drive  
Trentham Lakes  
Stoke-on-Trent  
ST4 4TJ

Technical Queries: 01782 339039  
Service Fault Enquiries: 01782 339008

**Spare Parts - [www.bfm-partfinder.co.uk](http://www.bfm-partfinder.co.uk)**