



Kenilworth & Linear Powerflue

**DECORATIVE FUEL EFFECT POWERFLUE GAS
FIRE**

Installation & Maintenance Instructions

Hand these instructions to the user

Model No. FGPCMN & FGPP**MN are for use on Natural Gas (G20)
at a supply pressure of 20 mbar in G.B. / I.E.**

CONTENTS

Section 1	Information and Requirements	PAGE
1.0	Appliance Information	3
1.1	Conditions of Installation	4
1.2	Flue Terminal Position	5
1.3	Fireplace / surround suitability	6
1.4	Fire place opening / catchment space	6
1.5	Shelf Position	6
1.6	Installation Types	7-9
1.7	Hearths	9
1.8	Spillage Monitoring System	9
Section 2	Installation of Fire	
2.1	Unpacking the fire	10
2.2	Marking the Flue Pipe Opening	10
2.3	Marking the Fan Unit Recess on the Outer Wall & Fitting the fire box	11-17
2.4	Making the Electrical Connections	18
2.5	Gas tightness and Inlet pressure	19
Section 3	Assembling Fuel Bed and Commissioning	
3.1	Assembling the ceramics and fuel bed (Pebble models)	20-22
3.2	Assembling the ceramics and fuel bed (Coal models)	23-26
3.3	Lighting the appliance	27
3.4	Checking for clearance of combustion products	28
Section 4	Maintenance	
4.1	Removal of the Burner Assembly	29
4.2	Removal of the Piezo Igniter	29
4.3	Removal of the Control Tap	30
4.4	Removal of the Oxypilot	30
4.5	Removal of the Solenoid	30-31
	Spare Parts Shortlist	31

This appliance is manufactured by :-

BFM Europe Ltd.
Trentham Lakes,
Stoke-on-Trent,
ST4 4TJ

SECTION 1 INFORMATION AND REQUIREMENTS

1.0 APPLIANCE INFORMATION

Model	FGPC**MN & FGPP**MN
Gas Type	G20
Main injectors (2 off)	Size 260
Pilot Type	Copreci Single Flame 21100 / 141
Max. Gross Heat Input :	6.9 kW
Min. Gross Heat Input :	4.2 kW
Cold Pressure :	20.0 +/-1.0 mbar
Ignition :	Push-button Piezo
Supply Voltage :	230V a.c.
Supply Frequency :	50 Hz
Supply Fuse :	3 Amp (Fixed Fused Spur) to BS 1362
IP Rating :	IP 44
Electrode Spark Gap :	4.0mm
Packed Weight :	18.5 kg Kenilworth Brass, 16.5 kg Black & Chrome
Packed Weight :	16.5 kg Linear Coal, 15.0 kg Linear Pebble
Fan Unit Packed Weight :	15 kg

Fire box Dimensions (with trim's fitted)

Fantasy Models

Width :	(with standard trim, no spacer)	470mm
Height :	(with standard trim, no spacer)	586mm
Depth :	(overall-without fender)	170mm
Depth :	(overall-with spacer fitted)	120mm

Gas Connection : 8mm Compression (Supplied with fire)

INSTALLATION REQUIREMENTS

1.1 CONDITIONS OF INSTALLATION

It is the law that all gas appliances are installed only by a CORGI Registered Installer, in accordance with these installation instructions and the Gas Safety (Installation and Use) Regulations 1998 as amended. Failure to install appliances correctly could lead to prosecution. It is in your own interest and that of safety to comply with the law.

The installation must also be in accordance with all relevant parts of the Local and National Building Regulations where appropriate, the Building Regulations (Scotland Consolidation) issued by the Scottish Development Department, and all applicable requirements of the following British Standard Code of Practice.

1. B.S. 5871 Part 3 Installation of Decorative Fuel Effect Gas Fires
2. B.S. 6891 Installation of Gas Pipework
3. B.S. 5440 Parts 1 & 2 Installation of Flues and Ventilation
4. B.S. 1251 Open fire place components
5. B.S. 715 Metal flue pipes for gas appliances
6. B.S. 6461 Part 1 Installation of Chimneys and flues
7. I.S. 813 : 1996 Domestic Gas Installation (Republic of Ireland)

No purpose made additional ventilation is normally required for this appliance, when installed in G.B. When Installing in I.E. please consult document I.S. 813 : 1996 Domestic Gas Installation, which is issued by the National Standards Authority of Ireland. If installing in Northern Ireland, please consult local building regulations. Any purpose made ventilation must be checked periodically to ensure that it is free from obstruction.

1.2 FLUE TERMINAL POSITION

The minimum acceptable dimensions from the flue terminal to obstructions and ventilation openings are shown below in fig. 1 and listed in the table (fig. 2 below) **IT IS IMPORTANT THAT THE POSITION OF THE FLUE ALLOWS THE FREE PASSAGE OF AIR ACROSS IT AT ALL TIMES.**

Fig. 1

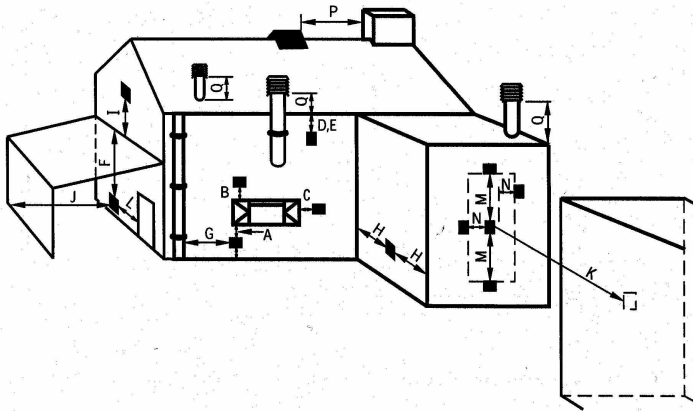

Fig. 2

DIMENSION	TERMINAL POSITION	MINIMUM DIMENSION
A	Directly below an opening, air brick, opening window	300mm (12 in.)
B	Above an opening, air brick, opening window	300mm (12 in.)
C	Horizontally to an opening, air brick, opening window etc.	300mm (12 in.)
D	Below gutters, soil pipes or drain pipes	75mm (3 in.)
E	Below eaves	200mm (8 in.)
F	Below balconies or car port roof	200mm (8 in.)
G	From a vertical drain pipe or soil pipe	150mm (6 in.)
H	From an internal or external corner	200mm (8 in.)
I	Above ground roof or balcony level	300mm (12 in.)
J	From a surface facing the terminal	600mm (24 in.)
K	From a terminal facing the terminal	1200mm (48 in.)
L	From an opening in the car port	1200mm (48 in.)
M	Vertically from a terminal on the same wall	1500mm (59 in.)
N	Horizontally from a terminal on the same Wall	300mm (12 in.)
O	From the wall on which the terminal is mounted	50mm (2 in.)
P	From a vertical structure on the roof	N/A
Q	Above intersection with roof	150mm

1.3 FIREPLACE / SURROUND SUITABILITY

The fire must only be installed on a hearth it must not be installed directly onto carpet or other combustible floor materials. The fire is suitable for fitting to non-combustible fire place surrounds and proprietary fire place surrounds with a temperature rating of at least 150⁰c. If a heating appliance is fitted directly against a wall without the use of a fire surround or fire place all combustible material must be removed from behind the trim. Soft wall coverings such as blown vinyl, wall paper etc. could be affected by the rising hot air and scorching and/or discoloration may result. Due consideration should be made to this when installing or decorating.

1.4 FIRE PLACE OPENING

The front opening of the fire place must be between 375 and 440 mm wide, and between 550 and 570mm high. If the opening exceeds these dimensions then a surround must be constructed from suitable non-combustible material to produce a correct size opening. Any surround must be suitably sealed to the fire place to prevent leakage. See below in fig.3

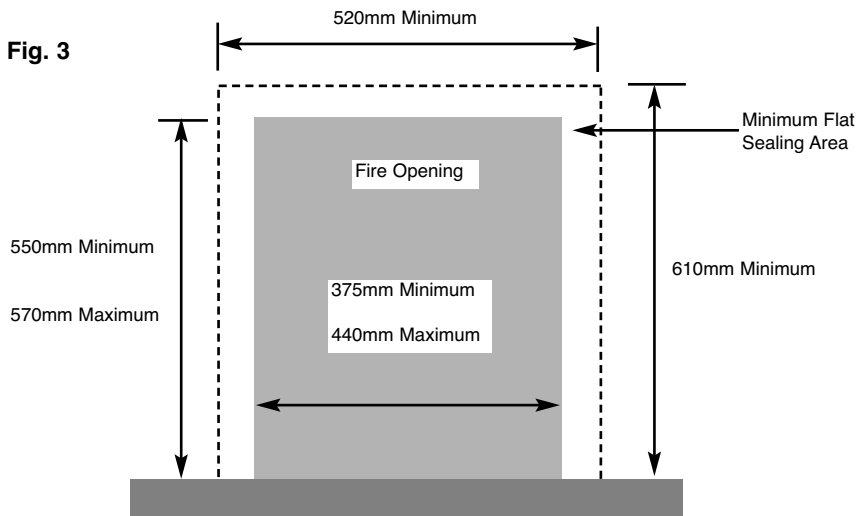

1.5 SHELF POSITION

The fire may be fitted below a combustible shelf providing there is a minimum distance of 200mm above the top of the fire and the shelf does not project more than 150mm. If the shelf overhangs more than 150mm the distance between the fire and the shelf must be increased by 15mm for every 25mm of additional overhang over 150mm.

1.6 INSTALLATION TYPES

This fire can be fitted against an outside facing flat wall surface or into a fireplace opening cut into the wall.

When fitting the fire in front of the inner cavity wall, the distance between the mounting face of the fire and the rear face of the firebox must be a minimum of 170mm, a false chimney breast or fireplace surround should be constructed. The firebox must then be secured into the fireplace using the method described in section 2. Any combustible material must be removed from the area around the firebox flange. In all installations, ensure that there is no structural damage to the property or the damp course. See fig. 4 below

Fig. 4

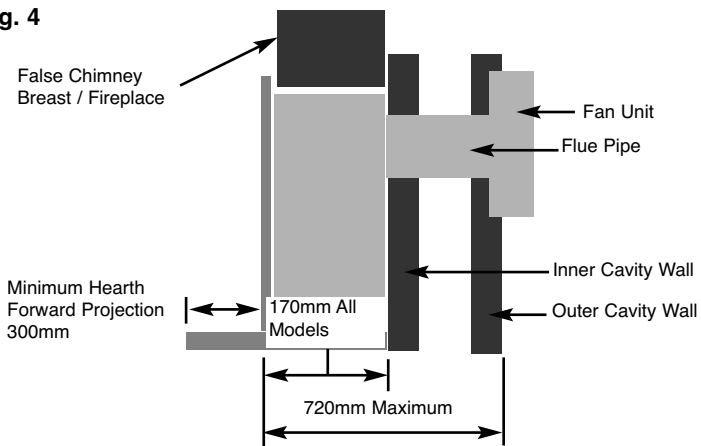

When fitting the fire into a cavity wall, this requires the opening of the inner leaf of brickwork, to recess the firebox into. The opening needs to be sufficient to accommodate the firebox. To support the wall above the hole, a suitable lintel must be inserted across the top of the opening. If fitting the appliance into a cavity wall, a lintel 600mm long having a thickness of 75mm with a height of the inner wall should be used. The lintel could be either pre-cast concrete or steel - Catnic CN52 or CN 46 could be used, depending upon the inner wall thickness. Before proceeding with the installation of the fire, an assessment of the area immediately above the fire is required, see Fig. 5 overpage. If there is no existing openings within either triangle, proceed with forming the opening. However, if opening or beams occur within either triangle, then you should seek specialist advice from a structural engineer or consider relocating the proposed position of the firebox.

Fig. 5

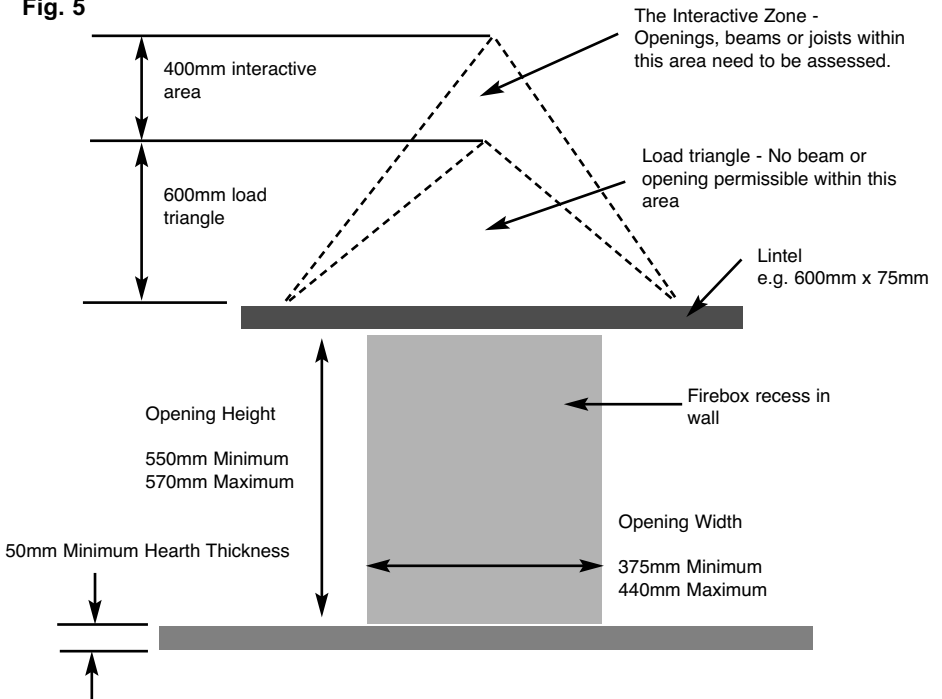

To proceed with the installation when the above stated criteria have been satisfied :-

Mark out where possible, centrally beneath a block joint where the lintel is to be fitted. Unless lime mortar has been used it will be necessary to drill four holes with a masonry drill, then use a mechanical cutter such as a "shark saw" to cut out the correct size of slot in the inner leaf of brickwork for the lintel you have chosen to install. See fig. 6 below.

Fig. 6

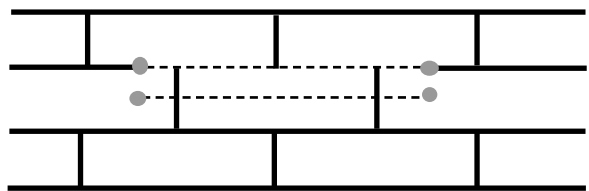

Fit the lintel, ensure that it is bedded on mortar. Do not bed on a dry bed. Then remove all debris from the cavity and construct the opening to the minimum / maximum opening sizes as shown overpage (fig. 7) and in section 1.4, (fig. 3)

Remove any combustible material from within the area of the opening. No combustible material can be allowed to come into contact with any area of the appliance.

Fig. 7

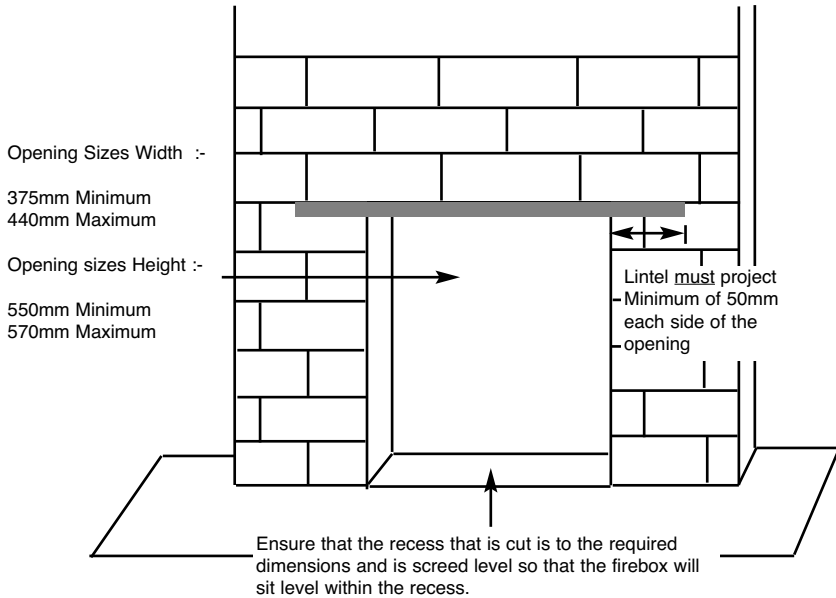

1.7 HEARTHES

This appliance must only be installed on to a concrete or non-combustible hearth. The hearth material must be a minimum thickness of 12mm with the top surface at least 50mm above the floor. The hearth must be fitted symmetrically about the fire opening and have a minimum width of 760mm and a minimum projection of 300mm forwards from the fire opening.

1.8 SPILLAGE MONITORING SYSTEM

This appliance is fitted with an atmosphere sensing spillage monitoring system in the form of an oxygen sensing burner. This is designed to shut the fire off in the event of a partial or complete blockage of the flue causing a build up of combustion products in the room in which the fire is operated. **The following are important warnings relating to this spillage monitoring system :-**

- 1) The spillage monitoring system must not be adjusted by the installer.
- 2) The spillage monitoring system must not be put out of operation.
- 3) When the spillage monitoring system is exchanged only a complete original manufacturers part may be fitted.

SECTION 2 INSTALLATION OF FIRE

2.1 UNPACKING THE FIRE

Carefully lift the fire out of the carton. Remove the loose item packaging carefully from the front of the appliance. Check the contents as listed :-

Packing Check List - All Models

1off	Fire box / burner assembly,
1off	Boxed fuelbed base, ceramic front rail and 18 synthetic coals or 14 synthetic pebbles
1off	Loose items bag including isolation valve and olive.
1off	Installation & Maintenance Instruction Book & User Instruction Book
1off	Trim & Fret or Fascia - colour / finish dependent upon model chosen
1off	Rope Seal (packed in fan unit - Pack 2 of 2)
1off	Boxed Fan Unit & Flue Pipe (Pack 2 of 2)

2.2 MARKING THE FLUE PIPE OPENING ON THE WALL (ALL MODELS)

Drill a pilot hole into the outer leaf of brickwork at a height of 490mm from the hearth level, centrally about the firebox, then create a square hole 100mm / 4 inch vertically central to the centre line of the appliance. See fig. 10 below.

NOTE : If the fire is to be fitted against the inner cavity wall, the inner and outer cavity walls will require the 100mm / 4 inch hole creating

Fig. 8

IMPORTANT NOTE :
**DO NOT FIT THIS APPLIANCE FAN UNIT ABOVE
A HEIGHT OF 1.4M FROM GROUND LEVEL**

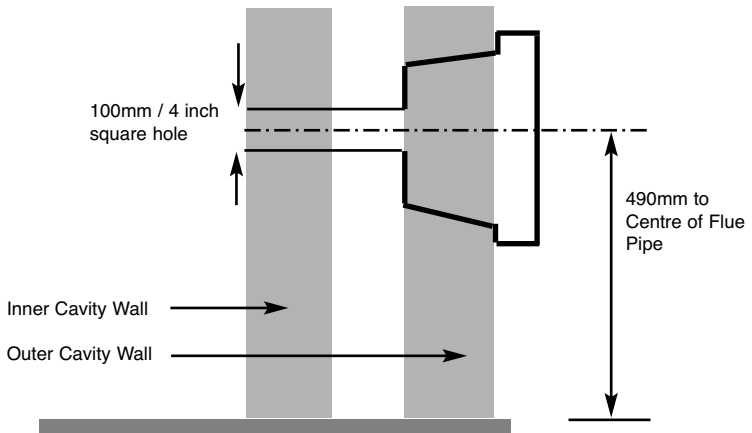

2.3 MARKING THE FAN UNIT RECESS ON THE OUTER WALL (ALL MODELS)

Fig. 9

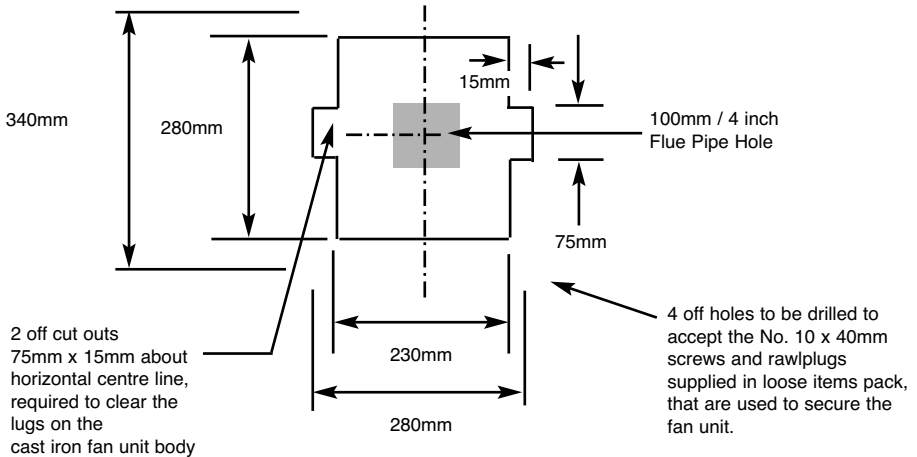

a) **The recess and mounting holes as detailed above will require cutting into the outer cavity of the wall to accept the fan unit cast iron body.**

b) To proceed with the installation, take the flue pipe (380mm in length) and secure to the firebox as shown below in Fig. 10, with the 3 off fixing screws supplied.

Fig. 10

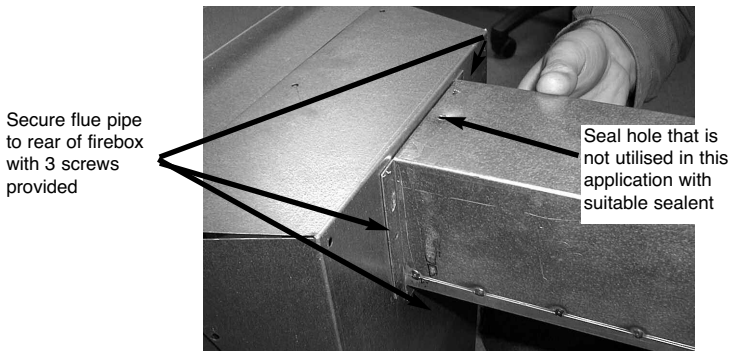

c) Carefully place the firebox and flue pipe together into the builders opening and allow the flue pipe to protrude through the hole in the outer cavity wall.

- d) Mark the flue pipe in line with the flue spigot so that it can be cut to length.

NOTE :- When cutting the flue pipe to length, allowance for the rebate on the fire surround used or false chimney breast constructed must be taken into account.

- e) The cover of the fan unit must now be removed to proceed with the installation. Remove the four off screws as shown below in Fig. 11

Fig. 11

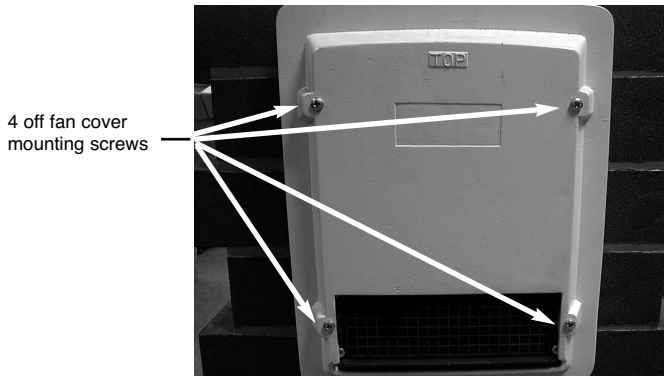

- f) Remove the 2 off screws for the electronic control board mounting plate as shown below in Fig. 12

Fig. 12

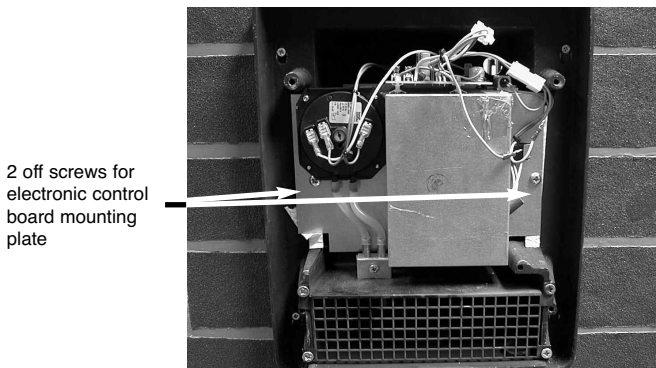

- f) With the fan cover removed, disconnect the air pressure switch tubes from the outlet venturi as shown below in Fig. 13, ensuring that you make a note of their location for when you re-fit them.

Fig. 13

Removing pipes
from the air
pressure switch

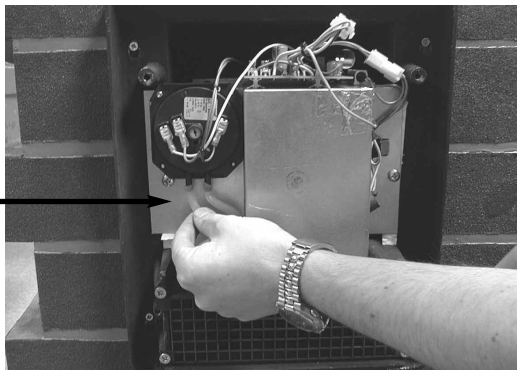

NOTE : If you re-fit the air pressure switch tubes the wrong way around, the appliance will not operate as a positive flue pressure cannot be generated, and hence the gas solenoid valve will not open.

- g) With the electronic control board mounting plate tilted forward, disconnect the positive, negative and earth wires from the fan unit as shown below in Fig. 14, ensuring that you make a note of their position for when you re-fit them.

Fig. 14

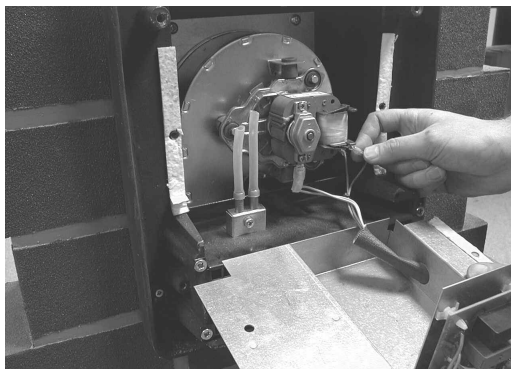

- h) Remove the 3 off fan mounting plate screws as shown overpage in Fig. 15

Fig. 15

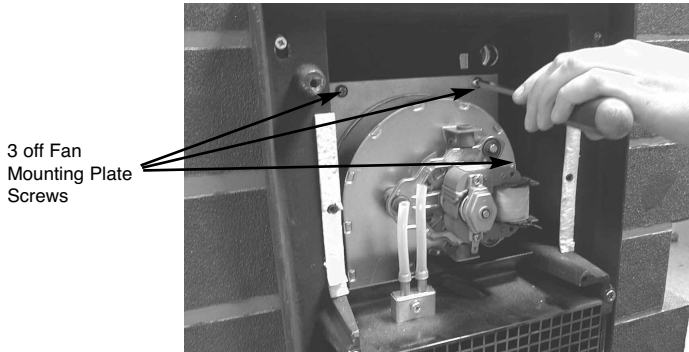

- i) Remove the firebox and flue pipe assembly from the false chimney breast or fire surround as applicable. Run the gas supply in from the right hand side of the firebox as shown below in Fig. 16

Fig. 16

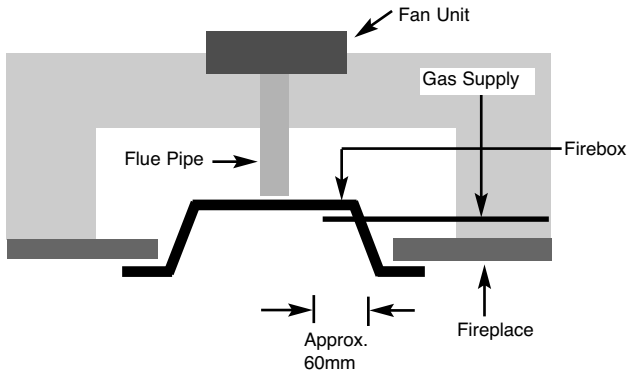

- j) Screw the cast iron fan unit housing to the outer cavity wall, using the screws and rawlplugs supplied.
- k) **The preferred method of fixing the firebox into place which is suitable for almost all situations is the cable fixing method which is described in the following section in detail.**

To fit using the **preferred** cable method proceed as follows-

- l) Mark out and drill 4 off No 14 (6mm) holes in the back face of the fire opening (inner face of the outer cavity wall in most instances) in the positions shown below in fig. 17

Fig. 17

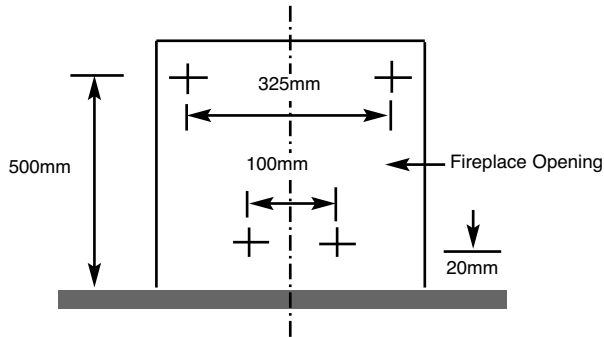

Fit the wallplugs provided and screw the fixing eyes securely into the rear of the fire opening. If the clearance at the rear of the fire is at the minimum specified for a powerflue application, it may be necessary to bend over the lower fixing eyes after screwing them fully in to the rear of the outer cavity wall inner face.

Proceed as follows to remove the burner assembly from the firebox :-

- m) Remove the trim. Remove the burner heat shield from the front of the fire box to allow access to the burner, as shown below in fig. 18

Fig. 18

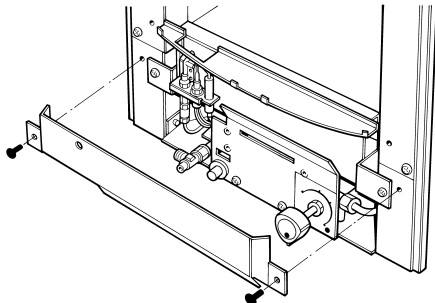

- i) Break the connection between the pressure test point elbow and the solenoid block. Remove the four retaining screws securing the burner to the firebox. The base of the burner unit can now be pulled forward, allowing the burner to be removed from the fire box. See fig. 19 overpage

Fig. 19

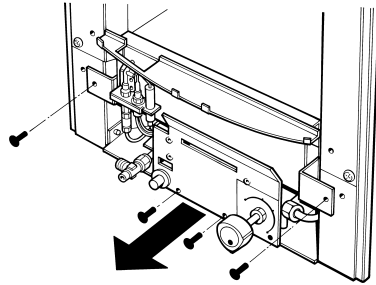

- m) Uncoil the two fire fixing cables and thread one end of each of the cables through one of the two holes on each side of the flue outlet shroud. **Electrical Wiring Loom** - Bring the 5 core cable from the fire box (with small 6 way plug attached) through the cable entry hole in the cast iron fan unit body, and secure to the wall plate with the strain relief bush, allowing at 150mm / 6 inches of wire to protrude into the wall plate.
- n) Position the fire carefully on the (protected) surface of the hearth and reach into the fire opening. Thread each of the cables vertically downwards through the pair of fixing eyes on the same side of the fire. Thread the free end of the cables through the corresponding circular hole on each side of the lower rear of the fire. Carefully slide the fire box back into the fire opening and pull both cables tight.
- o) Thread a tensioning screw over each of the cables and ensure that the tensioning nut is screwed fully up against the hexagon shoulder of the tensioning screw (this provides maximum travel for the tensioning nut).
- p) Fit a screwed nipple on to each of the cables and pull hand tight up against the tensioning screw, then secure each nipple with a flat bladed screwdriver. See fig. 20 below

Fig. 20

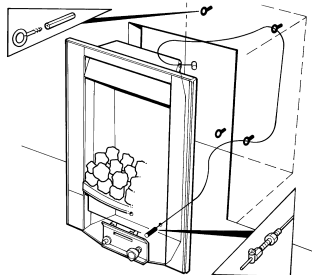

- q) Evenly tighten the tensioning nuts to tension both cables and pull the fire snugly against the wall. Do not overtighten, it is only necessary to pull the seal up against the sealing face of the wall, it does not need to be compressed. Check that there are no gaps behind the seal.
- r) With the fire securely in place, if a concealed gas connection has been made through the access holes in the R/H side of the fire, the hole should be closed around the pipe to prevent leakage of air through the gap around the pipe.
- s) Situate the isolation valve, supplied in the loose items pack at a convenient point in the installation.
- t) Refit the burner. Fit the four retaining screws and check that the burner is correctly locked into position. Before making the final gas connection to the solenoid valve, thoroughly purge the gas supply pipework to remove all foreign matter, otherwise serious damage may be caused to the gas control valve on the fire.
NOTE :- Failure to correctly purge the pipework will invalidate the guarantee
- u) It is now necessary to fit the rope seal between the spigot on the fan unit cast iron body and the flue pipe, as shown below in Fig. 21

Fig. 21

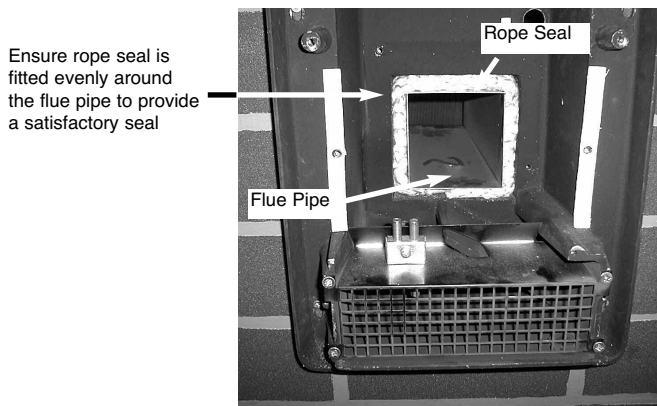

- w) Proceed to section 2.4 to make the electrical wiring connection

2.4 MAKING THE ELECTRICAL CONNECTION.

WARNING : THIS APPLIANCE MUST BE EARTHED AND MUST BE CONNECTED VIA A 3 AMP FIXED FUSED SPUR WITH A MINIMUM CONTACT SEPARATION OF 3MM - DO NOT UNDER ANY CIRCUMSTANCES CONNECT TO A 13AMP TYPE PLUG AND SOCKET

- a) Whilst feeding the 5 core cable through the cable entry hole in the fan unit, press the fan unit into the wall plate until it engages securely. Fix in position with the screws provided.
- b) Connect the 6 way miniature plug into the 6 way socket emerging from the circuit board, as shown below in Fig. 22

Fig. 22

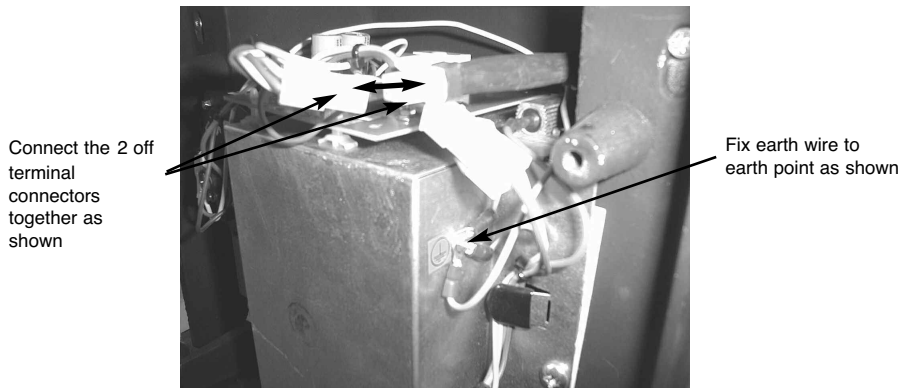

- c) Connect the earth wire from the wiring loom onto the fan enclosure earth point as shown above in Fig. 22
- d) Re-fit the painted fan box cover and secure with the screws provided.

2.5 GAS TIGHTNESS AND INLET PRESSURE

- a) Remove the pressure test point screw from the inlet elbow and fit a manometer.
- b) Turn on the main gas supply and carry out a gas tightness test.
- c) Depress and hold the green “on” button on the fan control panel, located at the right hand side of the fire (when viewed from the front). The fan unit will operate, and when the air pressure switch (located inside the fan unit) detects sufficient air flow within the flue, an audible click will be heard and the gas solenoid valve will open.
- d) Continue to hold-in the control knob and press the igniter button. If the burner does not light, continue to press the igniter button until ignition occurs. Continue to hold the control knob for a minimum of 10 seconds to allow the thermocouple to heat up, if the burner goes out when the control knob is released, repeat the lighting sequence.
- e) Check that the gas pressure is **20.0 mbar (+/- 1.0mbar) 8.0 in w.g.(+/- 0.4 in w.g.)**
- f) After removing the manometer, ensure that the pressure test point screw is checked for gas tightness with suitable leak detection spray or fluid.

SECTION 3.1 ASSEMBLING FUEL BED AND COMMISSIONING - (LINEAR PEBBLE MODELS)

NOTE : The position of the fuel-bed components are critical to the performance of the product. Therefore please ensure that the fuel-bed components are positioned as described in the following section prior to requesting a service call due to soot build up, poor flame pattern etc.

- a) Place the ribbed ceramic fuelbed base on top of the fuelbed support and pull fully forwards to the burner. **Make sure that the fuelbed base is located centrally in the fire box. Ensure that the fuelbed base fit fully down onto the fuel bed support and is not lodged on the burner. See fig. 23 below.**

Fig. 23

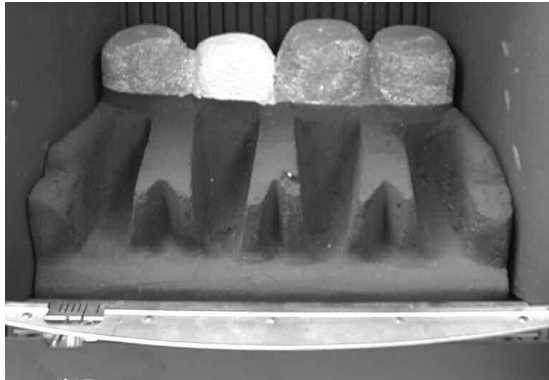

- b) Position front ceramic rail on burner front ceramic support and ensure that the locating channel in the front ceramic rail is correctly located onto the lip on the burner front ceramic support. (See fig. 24 below)

Fig. 24

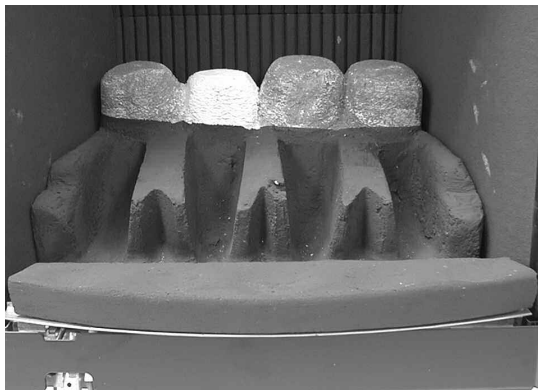

- c) Pick pebbles A to E and arrange along the the front rail, ensuring that they are evenly spaced. Use the recess's in the front ceramic rail as a guide for placement. (See fig. 25 below)

Fig. 25

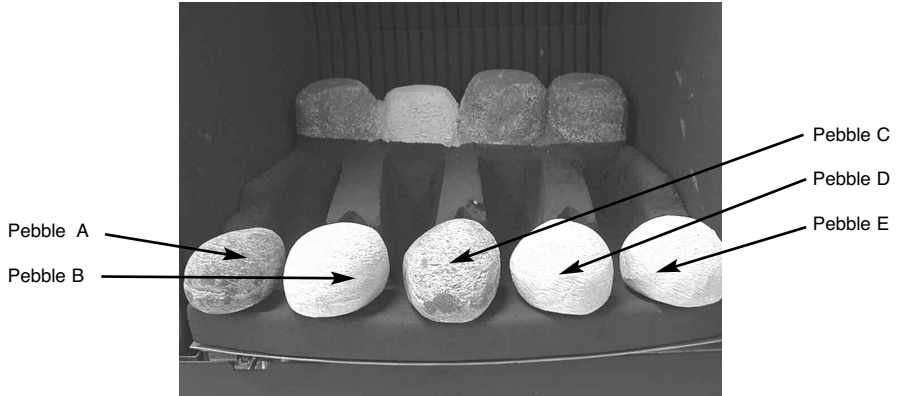

- d) Select pebbles F to I and arrange behind the front row of pebbles, ensuring that flame paths as indicated below are not interrupted. (See fig. 26 below)

Fig. 26

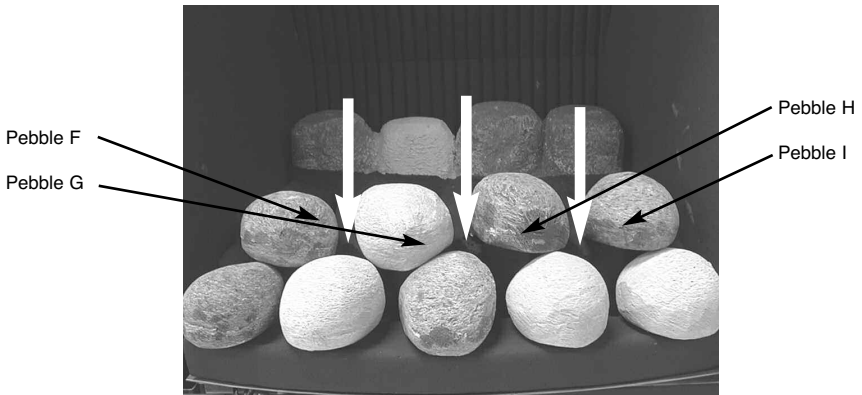

- e) Select pebbles K, L & M and arrange along the rear of the fuelbed, using the ribs in the rear of the fuelbed as a guide for placement. (See fig. 27 below)

Fig. 27

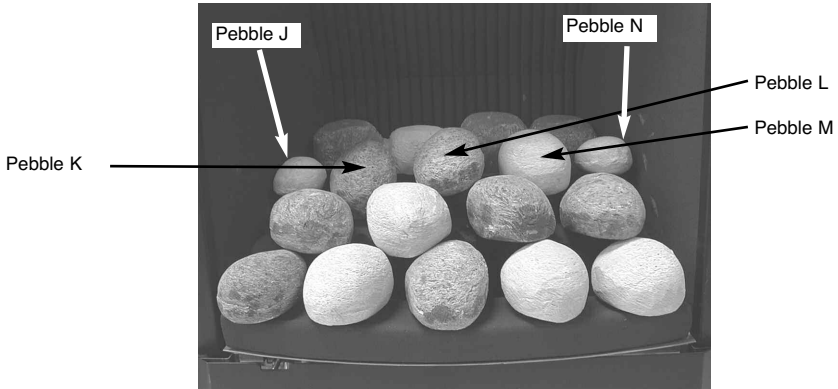

- f) Select the two small pebbles (J & N) and position to fill the gaps at each end of the third row of pebbles, as shown above in Fig. 27.

The exact position and fit of the pebbles may be finely adjusted to give the most pleasing and random appearance.

Warning : Use only the pebbles supplied with the fire. When replacing the pebbles remove the old pebbles and discard them. Fit a complete set of pebbles of the correct type. Do not fit additional pebbles or any pebbles other than a genuine replacement set.

To ensure that the release of fibres from these R.C.F (Refractory Ceramic Fibre) articles is kept to a minimum, during installation and servicing we recommend that you use a HEPA filtered vacuum to remove any dust accumulated in and around the appliance before and after working on the appliance. When replacing these articles we recommend that the replaced items are not broken up, but are sealed within heavy duty polythene bags, clearly labelled as “RCF waste”. RCF waste is classed as a “stable”, non reactive hazardous waste and may be disposed of at a landfill licensed to accept such waste. Protective clothing is not required when handling these articles, but we recommend you follow the normal hygiene rules of not smoking, eating or drinking in the work area, and always wash your hands before eating or drinking.

SECTION 3.2 ASSEMBLING FUEL BED AND COMMISSIONING - (LINEAR COAL & KENILWORTH MODELS)

NOTE : The position of the fuel-bed components are critical to the performance of the product. Therefore please ensure that the fuel-bed components are positioned as described in the following section prior to requesting a service call due to soot build up, poor flame pattern etc.

3.1B ASSEMBLING THE CERAMICS AND FUEL BED

- a) Place the ribbed ceramic fuelbed base on top of the fuelbed support and pull fully forwards to the burner. **Make sure that the fuelbed base is located centrally in the fire box. Ensure that the fuelbed base fit fully down onto the fuel bed support and is not lodged on the burner. See fig. 28 below.**

Fig. 28



- b) Position the two halves of the front ceramic (L/H & R/H) on the locating channel in the front ceramic, ensuring it is located onto the lip on the burner front ceramic support. (See fig. 29 below)

Fig. 29

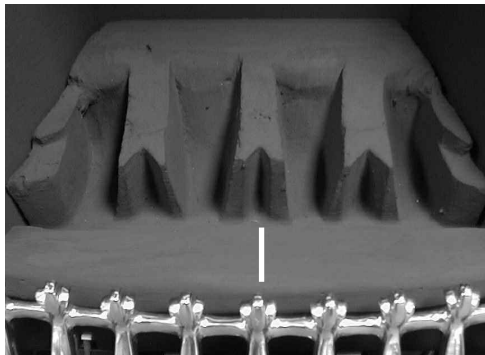

- c) Fit five of the large sized coals onto the front ceramic rail, ensuring that they are evenly spaced. Use the recess's in the front ceramic rail as a guide for placement. (See fig. 30 below)

Fig. 30



- d) Select four of the large coals and arrange behind the front row of coals, ensuring that flame paths as indicated below are not interrupted. (See fig. 31 below)

Fig. 31

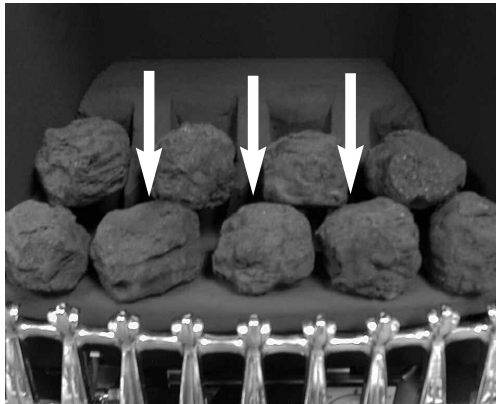

- e) Select three of the large coals and arrange along the rear of the fuelbed, using the ribs in the rear of the fuelbed as a guide for placement. (See fig. 32 below)

Fig. 32



- f) Select the two small coals and position to fill the gaps at each end of the third row of coals, as shown. below in Fig. 33

Fig. 33



- g) Select the remaining four coals and position along the rear edge of the fuelbed (See fig. 34 below)

Fig. 34



The exact position and fit of the coals may be finely adjusted to give the most pleasing and random appearance.

Warning : Use only the coals supplied with the fire. When replacing the coals remove the old coals and discard them. Fit a complete set of coals of the correct type. Do not fit additional coals or any coals other than a genuine replacement set.

To ensure that the release of fibres from these R.C.F (Refractory Ceramic Fibre) articles is kept to a minimum, during installation and servicing we recommend that you use a HEPA filtered vacuum to remove any dust accumulated in and around the appliance before and after working on the appliance. When replacing these articles we recommend that the replaced items are not broken up, but are sealed within heavy duty polythene bags, clearly labelled as “RCF waste”. RCF waste is classed as a “stable”, non reactive hazardous waste and may be disposed of at a landfill licensed to accept such waste. Protective clothing is not required when handling these articles, but we recommend you follow the normal hygiene rules of not smoking, eating or drinking in the work area, and always wash your hands before eating or drinking.

3.3 LIGHTING THE APPLIANCE (ALL MODELS)

- a) Turn on the gas isolation tap.
- b) Depress and hold the green “on” button on the fan control panel, located at the right hand side of the fire (when viewed from the front). The fan unit will operate, and when the air pressure switch (located inside the fan unit) detects sufficient air flow within the flue, an audible click will be heard and the gas solenoid valve will open.
- c) Depress the control knob and turn anti-clockwise to the position marked ignition / low rate. Hold in the control knob for a few seconds to purge the pipe work.
- d) Continue to hold-in the control knob and press the igniter button. If the burner does not light, continue to press the igniter button until ignition occurs. Continue to hold the control knob for a minimum of 10 seconds to allow the thermocouple to heat up, if the burner goes out when the control knob is released, repeat the lighting sequence.
- e) Turn the control knob in the anti-clockwise direction to the high position and the gas rate will increase to high rate (6.9 kW)
- f) Turn the control knob clockwise to the low position and the gas input will be reduced to the minimum setting (2.5 kW)
- g) Slightly depress the control knob and turn to the off position, the burner will now be extinguished.

WARNING : If the fire goes out for any reason or is turned off and it is necessary to re-light the fire it is important to allow the fire to cool for 3 minutes before attempting to re-light it.

3.4 CHECKING FOR CLEARANCE OF COMBUSTION PRODUCTS (ALL MODELS)

- a) Close all doors and windows in the room.
- b) Light the fire and allow to run for approximately 5 minutes on high position.
- c) After approximately 5 minutes hold a smoke match just inside and below the centre of the lower front edge of the top of the fire. (It is recommended that a suitable smoke match holder is used when checking for clearance of combustion products). All smoke generated should be drawn back into the flue. If slight spillage occurs or if in doubt, repeat the test after a further 5-10 minutes.

If the test indicates that spillage is occurring, check that the supply voltage to the appliance is 230V (+/- 5%). If the supply voltage is outside these parameters, this could be causing the appliance to spill. Obtain the correct supply voltage and re-test the appliance from cold.

- d) If spillage persists, the fan unit is not functioning correctly and a fault exists. If, after investigation the fault cannot be traced and rectified, the fire must be disconnected from the gas supply and expert advice obtained from the manufacturer.
- e) If there is an extractor fan fitted anywhere in the vicinity of the appliance, the spillage test should be repeated with the fan running on maximum and all interconnecting doors open.
- f) After ensuring that the fire is safe to use it should be left on high position to fully warm up. During this time a slight odour may be noticed, this is due to the "newness" of the fire and will soon disappear.

At this stage any minor adjustments to the coals should be made using suitable long handled tongs and taking care not to damage the coals.

Finally, hand the Installation and Maintenance Instructions and the Users Instructions over to the customer and explain the operation of the fire.

SECTION 4 MAINTENANCE

Servicing Notes

Servicing should be carried out annually by a competent person such as a CORGI registered engineer. **This is a condition of the Flavel guarantee schemes.**

The service should include visually checking the chimney and fire opening for accumulations of debris and a smoke test to check for a positive up-draught in the chimney.

The condition of the coals should be checked and **if necessary the whole set should be replaced with a genuine replacement set.**

The burner assembly is designed to be removed as a complete unit for ease of access. **After any servicing work a gas tightness check must always be carried out. All sections apply for both Kenilworth & Linear Coal / Pebble models**

For Diagrams refer to Section 2

4.1 Removing the burner assembly from the fire.

4.1.1 Prepare work area (lay down dust sheets etc.)

4.1.2 Lift the trim and ash pan cover / fret out of the way and put them in a safe location. Remove the loose pebbles or coals from the fuel bed. Remove the front ceramic from the rail. Unscrew the two pozi-driv fixing screws which secure the burner heat shield and remove it from the fire.

4.1.3 Isolate the gas supply at the valve behind the burner assembly, accessible through over the on / off switch at the RHS. Remove the inlet pipe from the pressure test point elbow. Unscrew and remove the four screws which retain the burner. Remove the burner assembly from the fire. Disconnect the two leads from the on / off switch.

4.1.4 To refit the burner assembly. Push the base of the control panel fully into the fire and secure with the four screws. Refit the gas supply pipe and carry out a gas tightness test. Refit the burner heat shield then refit the fuelbed referring to section 3.1 / 3.2 for the correct layout. The trim and fret / ash pan cover can now be re-positioned.

4.2 Removing the Piezo Igniter (All models).

4.2.1 Isolate the appliance from the gas and electricity supply.

4.2.2 Remove the burner assembly as in section 4.1

- 4.2.3 Disconnect the ignition lead from the piezo and unscrew the retaining nut on the rear of the control panel. Withdraw the piezo from the front of the control panel. Re-assemble in reverse order and carry out a gas tightness test. Ensure the heatshield is re-fitted.

4.3 Removing the Control Tap from the fire.

- 4.3.1 Remove the burner assembly as in section 4.1.
- 4.3.2 Pull the control knob off the control tap spindle.
- 4.3.3 Loosen and remove the three gas pipe retaining nuts from the control tap and release the ends of the gas pipes from the control tap body. Loosen and remove the thermocouple securing nut from the end of the control tap.
- 4.3.4 Unscrew the control tap locknut from the front of the control panel and remove the control tap.
- 4.3.5 To refit a control tap, reassemble in reverse order noting that the control tap locates with a flat in the control panel. Carry out a gas tightness test after re-assembly.

4.4 Removing the Oxy-Pilot Assembly

Note : Because this appliance is fitted with an atmosphere sensing ‘Oxy-Pilot’ it is not possible to replace the thermocouple separately, because the thermocouple position is factory set to a tight tolerance. Any replacement of parts on the pilot requires a complete new pilot assembly.

Note : Prior to replacing the oxypilot on this product due to suspected failure of the component, please remove all debris that has collected on the lint guard of the oxypilot itself.

- 4.4.1 Remove the burner assembly as in section 4.1
- 4.4.2 Unscrew and remove the thermocouple retaining nut from the end of the control tap and disconnect the ignition lead from the pilot electrode.
- 4.4.3 Unscrew and remove the two pozi-driv screws which secure the pilot assembly to the burner. Remove the pilot.
- 4.4.4 Re-assemble in reverse order and carry out a gas tightness test.

4.5 Removing the Solenoid Valve (All models).

- 4.5.1 Isolate the appliance from the gas and electricity supply.

- 4.5.2 Remove the burner assembly as described in section 4.1
- 4.5.3 Disconnect the solenoid plug from the harness.
- 4.5.4 Unscrew the solenoid pipe from the retaining brackets.
- 4.5.5 Remove solenoid from pipe and refit new solenoid.

PARTS SHORTLIST

Replacement of any other parts must be carried out by a competent person such as a CORGI registered gas installer. The part numbers of the main replaceable parts are as follows, these are available from BFM Europe Ltd. (see rear page for contact details)

Pressure Switch	GC-4209
Solenoid Valve	GC-4123
Fan Motor	50-35860
Circuit Board (Supplied with Wiring Harness)	GC-4221
Fuelbed base (Coal models)	B-56320
Fuelbed base (Pebble models)	B-77260
Fuelbed front rail (pebble models)	B-58140
Replacement pebble set	B-77250
Fuelbed front ceramics rails (coal models)	B-56330
Replacement coal set & ceramics	B-56960
Manual Gas Valve	B-102880

Due to our policy of continual improvement and development the exact accuracy of illustrations and descriptions contained in this book cannot be guaranteed

Part no. B-103960
Issue 2



BFM Europe Ltd
Trentham Lakes
Stoke-on-Trent
Staffordshire
ST4 4TJ

www.bfm-europe.com

Telephone - General Enquiries : (01782) 339000
Telephone - Service / Repair : (08700) 101187